

**TWINCHESTER**<sup>®</sup>

REPEATING ARMS



**SX4**<sup>™</sup>  
BUILT **4** SPEED

**2017**  
CATALOG



# 2017

## CONTENTS

**SUPER X<sup>®4</sup>**  
PAGES 2-7

**SUPER X<sup>®3</sup>**  
PAGES 8-17

**SUPER X<sup>®</sup> PUMP**  
PAGES 18-35

**MODEL 101<sup>®</sup>**  
PAGES 36-41

**HISTORICAL**  
PAGES 42-57

**XPR<sup>®</sup>**  
PAGES 58-63

**MODEL 70<sup>®</sup>**  
PAGES 64-73

**ACCESSORIES**  
PAGES 74-77

**EXPERTS**  
PAGES 78-81

# A MESSAGE WORTH REPEATING

## FROM WINCHESTER REPEATING ARMS

For more than 150 years Winchester Repeating Arms has created legendary firearms using innovative design, quality materials and precision manufacturing processes to deliver the kind of products that you want and need.

That was the standard in 1866 when Oliver Winchester unveiled a magnificent polished brass repeater that soon became known as the "Yellow Boy." In 2016 a magnificently engraved and embellished Model 1866 was the flagship of the 150th anniversary commemorative lineup for Winchester Repeating Arms. For 2017 the legendary Model 1866 is now available in a Grade I Short Rifle, making the "Yellow Boy" experience readily affordable for cowboy action shooters, hunters, casual shooters and everyone who enjoys spending a day at the range with a genuine Winchester lever-action classic.

That same ideal has been applied to create the new Super X<sup>®4</sup> autoloading shotgun. Based on the proven Active Valve gas system, the new Super X<sup>®4</sup> offers enhanced ergonomics, easier to access operating controls, lighter weight, a more fluid swing, faster cycling speed and the proven reliability you've come to expect from Winchester Repeating Arms.

Also new this year is a Compact version of the popular and accurate XPR<sup>®</sup> centerfire rifle, perfectly sized for shooters of smaller stature. This new rifle allows more people of all ages to enjoy the accuracy and performance of the XPR.

Yes, the 2017 product line up from Winchester Repeating Arms carries a message worth repeating. The name Winchester will always represent The American Legend.

See the full line for yourself at your local Winchester Repeating Arms retailer or visit [winchesterguns.com](http://winchesterguns.com)



# SAV4™

BUILT  SPEED

# SUPER X<sup>®</sup>4

## THE AUTOLOADING SHOTGUN THAT'S BUILT 4 SPEED.

WINCHESTER SUPER X<sup>®</sup> AUTOLOADING SHOTGUNS HAVE A WORLDWIDE REPUTATION FOR SPEED, RELIABILITY AND HANDLING. THE SUPER X<sup>®</sup>3 WAS A TOUGH ACT TO FOLLOW, AND MAKING THE SUPER X<sup>®</sup>4 EVOLUTION OF THIS POPULAR SHOTGUN SERIES EVEN BETTER THAN ITS PREDECESSOR WAS A REAL CHALLENGE. THAT'S EXACTLY WHAT THE GIFTED DESIGN ENGINEERS AT WINCHESTER REPEATING ARMS HAVE DONE. THE NEW SUPER X4 IS LIGHTER, FASTER CYCLING, SMOOTHER SWINGING AND MORE ERGONOMIC THAN EVER BEFORE. THE NEW SUPER X4 IS THE AUTOLOADING SHOTGUN THAT IS BUILT 4 SPEED.



One of the first things experienced shooters notice about the new Super X<sup>®</sup>4 is the gun's **IMPROVED ERGONOMICS**. It's **LIGHTER OVERALL** and **THE PISTOL GRIP IS SLIMMER AND MORE ERGONOMIC**, regardless of which hand you use to pull the trigger. The gun's overall balance point has been moved slightly forward to **CREATE A MORE FLUID SWING, BETTER TARGET TRACKING AND SMOOTHER FOLLOW-THROUGH**.



The fit and balance of a shotgun stock are critical factors of how well you're able to shoot it. The new Super X<sup>®</sup>4 comes with polymer **LENGTH OF PULL SPACERS** that fit between the stock and the recoil pad. When adjusted properly you shoulder the shotgun with a smooth confidence and "felt recoil" is greatly diminished. Synthetic stock Super X4 models come with one spacer already installed to provide a standard 14 1/4" length of pull, and include one additional spacer in the box. Wood stock models include two length of pull spacers in the box. When you remove or add a spacer, you change the length of pull by 1/4". Additional spacers are available from your Winchester Repeating Arms dealer, allowing you to custom fit the Super X4 to your exact length of pull.

The newest evolution of the **INFLEX TECHNOLOGY RECOIL PAD ON THE SUPER X<sup>®</sup>4 FURTHER REDUCES "FELT RECOIL."** Specially shaped rib structures located inside the pad help direct and channel the recoil impulse, moving the comb down and away from your cheek to reduce "felt recoil" to very manageable levels, even when shooting heavy magnum loads. The new pad's **LARGER FOOTPRINT SPREADS RECOIL FORCES OVER A WIDER AREA** for further cushioning.



The new Super X<sup>®</sup>4 features a **LARGER BOLT HANDLE** and an **OVERSIZED BOLT RELEASE BUTTON** for easier engagement and faster operation; two very important features when your hands are cold and wet or when you're wearing gloves. The shell carrier and bolt release button are coated with Nickel Teflon<sup>®</sup> to reduce friction and help prevent corrosion.



The larger, easier to operate **AMBIDEXTROUS SAFETY** button on the Super X<sup>®</sup>4 is located at the rear of the angular-profile trigger guard and is easily reversible for both right- or left-handed shooters. The opening on **THE TRIGGER GUARD IS GENEROUSLY SIZED FOR EASIER ACCESS**, even when wearing heavy gloves.

# SX4

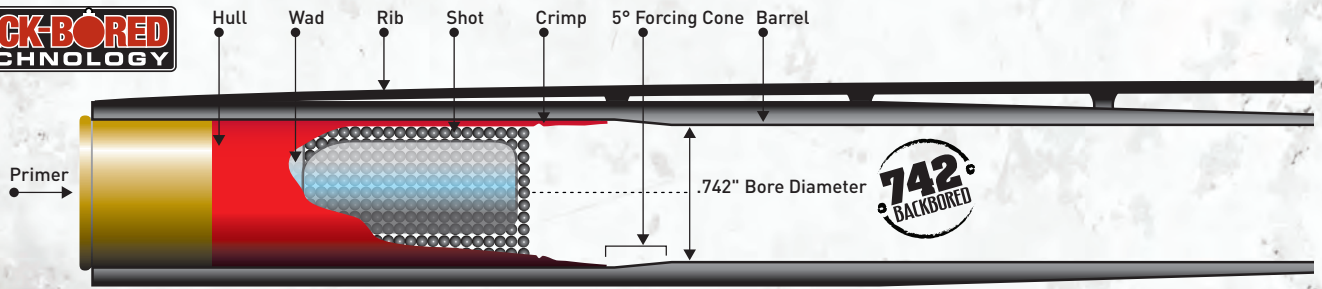

**BACK-BORED TECHNOLOGY** is based on extensive research and testing to find the secret to tighter, more consistent patterns. Instead of the traditional bore size of .729", this research shows the ideal 12 gauge interior diameter is .742". If the bore is any larger, the gases will blow by the shot cup and reduce pellet velocity. If the bore is too tight the pellets are deformed as they pass through the forcing cone, causing poor ballistic performance.

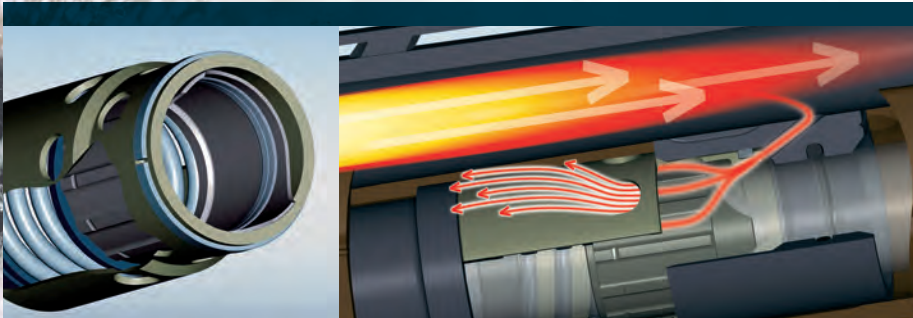

Like the original Super X<sup>®</sup>3, the Super X<sup>®</sup>4 uses the proven **ACTIVE VALVE GAS SYSTEM** that automatically self-adjusts to allocate the exact gas pressure necessary to reliably cycle a wide range of loads commonly used for hunting or target shooting. When firing the heaviest magnum loads in 3 1/2"

models, gases vent upward and a portion of them are vented forward out the Quadra-Vent ports in the forearm to help regulate bolt speed. Both 3" and 3 1/2" Super X4 shotguns will reliably cycle even 1 1/8 oz., 2 3/4" light loads. Excess gases from heavy loads are channeled through the forward **QUADRA-VENT™** ports for cleaner and more reliable operation.



**LOAD DIVERSITY** means a Super X<sup>®</sup>4 can reliably shoot them all, from light factory field shells to heavy magnum waterfowl and turkey loads. That's why the proven Active Valve on the Super X4 makes it the most versatile autoloader on the range, in the marsh and in the field.



The Super X<sup>®</sup>4 has a **DROP-OUT TRIGGER GROUP** that's easy to remove for detailed cleaning or lubrication. The **SELF ALIGNING BOLT CARRIER LINK** makes it easier than ever to reassemble.



**CHROME-PLATED CHAMBER AND BORE** are critical for today's steel or Hi-Density (HD) shot. Hard chrome makes the surfaces highly resistant to wear and gives you superior protection from rust and corrosion. That's why all smoothbore Super X<sup>®</sup>4 shotguns feature a hard-chromed chamber and bore.



From the duck blind to the firing line, the **INVECTOR-PLUS CHOKE TUBE SYSTEM** is the world's most consistent. Because the threads are located at the bottom of the choke tube they seal out corrosive gases better. The tube's thicker walls make Invector-Plus chokes much stronger than any other choke tube system, yet they remain easy to remove and clean. They are more concentric with the bore and thus produce more even, consistent shot patterns. The Super X<sup>®</sup>4 comes with full, modified and improved cylinder flush-mounted choke tubes so your gun is ready for anything, right out of the box. Additional choke tubes are available at your local Winchester Repeating Arms dealer.

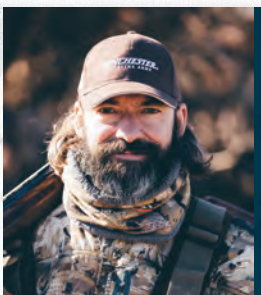

**"AFTER SPENDING CONSIDERABLE TIME WITH THE NEW SUPER X<sup>®</sup>4, ITS FEEL AND POINTABILITY ARE SECOND TO NONE."**  
— John Stephens • RNT-V

# SMOKIN' HOT.

BUILT 4 SPEED MEANS FAST SWINGING AND FAST CYCLING.



**"NO MATTER THE CONDITIONS THE SUPER X<sup>®</sup>4, WHEN CALLED UPON WILL DO ITS JOB EVERY TIME YOU PULL THE TRIGGER."**

— Jim Ronquest • RNT-V



# SX4™





F, M, IC



**SX4**

- **SYNTHETIC STOCK WITH IMPROVED ERGONOMICS, A SMALLER PISTOL GRIP AND TEXTURED GRIPPING SURFACES** give your hands a sure, non-slip grip. The non-glare matte black finish won't spook wary game
- **BACK-BORED TECHNOLOGY** provides optimum shot patterns that are dense and even
- **INVECTOR-PLUS CHOKE TUBE SYSTEM** offers consistent patterns to match your target situation
- **HARD CHROME-PLATED CHAMBER AND BORE** make these surfaces highly resistant to wear and corrosion
- **TRUGLO® LONG BEAD™ FIBER-OPTIC FRONT SIGHT** offers a true, precise sight picture
- **VENT RIB** gives you a smooth, clean sighting plane

- **SELF-ADJUSTING ACTIVE VALVE SYSTEM** cycles a wide variety of loads while reducing felt recoil
- **QUADRA-VENT™ PORTS** vent excess gases for cleaner operation
- **DROP-OUT TRIGGER GROUP** allows for easy cleaning
- **AMBIDEXTROUS CROSSBOLT SAFETY** is easily reversible
- **LARGER BOLT HANDLE AND BOLT RELEASE BUTTON** are faster and easier to operate
- **LENGTH OF PULL SPACERS** allow stock adjustments to achieve a perfect fit
- **INFLEX TECHNOLOGY RECOIL PAD** directs "felt recoil" down and away from your cheek to reduce flinch and fatigue



F, M, IC



**WATERFOWL HUNTER**

- **SYNTHETIC STOCK WITH IMPROVED ERGONOMICS, A SMALLER PISTOL GRIP AND TEXTURED GRIPPING SURFACES** give your hands a sure, non-slip grip. Full coverage Mossy Oak® Shadow Grass Blades camo finish means your gun won't spook wary waterfowl
- **BACK-BORED TECHNOLOGY** provides optimum shot patterns that are dense and even
- **INVECTOR-PLUS CHOKE TUBE SYSTEM** offers consistent patterns to match your target situation
- **HARD CHROME-PLATED CHAMBER AND BORE** make these surfaces highly resistant to corrosion and wear from steel shot
- **VENT RIB** gives you a smooth, clean sighting plane

- **TRUGLO® LONG BEAD™ FIBER-OPTIC FRONT SIGHT** offers a true, precise sight picture
- **ACTIVE VALVE GAS SYSTEM** cycles a wide variety of loads while reducing felt recoil
- **QUADRA-VENT™ PORTS** vent excess gases for cleaner operation
- **DROP-OUT TRIGGER GROUP** allows for easy cleaning
- **AMBIDEXTROUS CROSSBOLT SAFETY** is easily reversible
- **LARGER BOLT HANDLE AND BOLT RELEASE BUTTON** are faster and easier to operate
- **LENGTH OF PULL SPACERS** allow stock adjustments to achieve a perfect fit
- **INFLEX TECHNOLOGY RECOIL PAD** directs "felt recoil" down and away from your cheek to reduce flinch and fatigue

	ITEM NUMBER	GAUGE	BARREL LENGTH	CHAMBER	MAGAZINE CAPACITY	CHOKE TUBES INCLUDED	OVERALL LENGTH	LENGTH OF PULL	DROP AT COMB	DROP AT HEEL	NOMINAL WT. (LBS.)	SUGGESTED RETAIL
<b>SX4</b>												
<b>NEW</b>	511205291	12	26"	3 1/2"	4*	F, M, IC	47"	14 1/4"	1 3/4"	2"	7	\$939.99
<b>NEW</b>	511205292	12	28"	3 1/2"	4*	F, M, IC	49"	14 1/4"	1 3/4"	2"	7 1/8	939.99
<b>NEW</b>	511205391	12	26"	3"	4*	F, M, IC	47"	14 1/4"	1 3/4"	2"	7	799.99
<b>NEW</b>	511205392	12	28"	3"	4*	F, M, IC	49"	14 1/4"	1 3/4"	2"	7 1/8	799.99
<b>SX4 WATERFOWL HUNTER</b>												
<b>NEW</b>	511206291	12	26"	3 1/2"	4*	F, M, IC	47"	14 1/4"	1 3/4"	2"	7	\$1,069.99
<b>NEW</b>	511206292	12	28"	3 1/2"	4*	F, M, IC	49"	14 1/4"	1 3/4"	2"	7 1/8	1,069.99
<b>NEW</b>	511206391	12	26"	3"	4*	F, M, IC	47"	14 1/4"	1 3/4"	2"	7	939.99
<b>NEW</b>	511206392	12	28"	3"	4*	F, M, IC	49"	14 1/4"	1 3/4"	2"	7 1/8	939.99

\*TOTAL AMMUNITION CAPACITY INCLUDES ONE ADDITIONAL SHELL IN THE CHAMBER

# SPEED CHECK.

REAL CHECKERED WALNUT  
BUILT 4 SPEED.



# 574







- **SATIN OIL FINISH WALNUT STOCK WITH CLASSIC CUT CHECKERING, IMPROVED ERGONOMICS AND A SMALLER PISTOL GRIP** enhance control and look elegant
- **MATTE BLACK RECEIVER** is strong, lightweight aluminum alloy to reduce weight for easy carrying
- **BACK-BORED TECHNOLOGY** provides optimum shot patterns that are dense and even
- **VENT RIB** gives you a smooth, clean sighting plane and helps reduce weight
- **TRUGLO® LONG BEAD™ FIBER-OPTIC FRONT SIGHT** offers a true, precise sight picture

- **HARD CHROME-PLATED CHAMBER AND BORE** make these surfaces highly resistant to wear and corrosion
- **INVECTOR-PLUS CHOKE TUBES** offer consistent, reliable patterns
- **ACTIVE VALVE SYSTEM** cycles a wide variety of loads while reducing felt recoil
- **INFLEX TECHNOLOGY RECOIL PAD** directs "felt recoil" down and away from your cheek to reduce flinch and fatigue
- **AMBIDEXTROUS CROSSBOLT SAFETY** is easily reversible
- **LARGER BOLT HANDLE AND BOLT RELEASE BUTTON** are faster and easier to operate
- **DROP-OUT TRIGGER GROUP** allows for easy cleaning



- **COMPACT 13" LENGTH OF PULL** to better fit smaller statured shooters
- **SATIN OIL FINISH WALNUT STOCK WITH CLASSIC CUT CHECKERING, IMPROVED ERGONOMICS AND A SMALLER PISTOL GRIP** improve control and look elegant
- **MATTE BLACK RECEIVER** is strong, lightweight aluminum alloy to reduce weight for easy carrying
- **BACK-BORED TECHNOLOGY** provides optimum shot patterns that are dense and even
- **VENT RIB** gives you a smooth, clean sighting plane and helps reduce weight
- **TRUGLO® LONG BEAD™ FIBER-OPTIC FRONT SIGHT** offers a true, precise sight picture

- **HARD CHROME-PLATED CHAMBER AND BORE** make these surfaces highly resistant to wear and corrosion
- **INVECTOR-PLUS CHOKE TUBES** offer consistent, reliable patterns
- **ACTIVE VALVE SYSTEM** cycles a wide variety of loads while reducing felt recoil
- **INFLEX TECHNOLOGY RECOIL PAD** directs "felt recoil" down and away from your cheek to reduce flinch and fatigue
- **AMBIDEXTROUS CROSSBOLT SAFETY** is easily reversible
- **LARGER BOLT HANDLE AND BOLT RELEASE BUTTON** are faster and easier to operate
- **DROP-OUT TRIGGER GROUP** allows for easy cleaning

	ITEM NUMBER	GAUGE	BARREL LENGTH	CHAMBER	MAGAZINE CAPACITY	CHOKE TUBES INCLUDED	OVERALL LENGTH	LENGTH OF PULL	DROP AT COMB	DROP AT HEEL	NOMINAL WT. (LBS.)	SUGGESTED RETAIL
<b>SX4 FIELD</b>												
NEW	511210391	12	26"	3"	4*	F, M, IC	47"	14 1/4"	1 1/2"	1 3/4"	6 5/8	\$939.99
NEW	511210392	12	28"	3"	4*	F, M, IC	49"	14 1/4"	1 1/2"	1 3/4"	6 3/4	939.99
<b>SX4 FIELD COMPACT</b>												
NEW	511211390	12	24"	3"	4*	F, M, IC	43 3/4"	13"	1 1/2"	1 3/4"	6 5/8	\$939.99
NEW	511211391	12	26"	3"	4*	F, M, IC	45 3/4"	13"	1 1/2"	1 3/4"	6 3/4	939.99
NEW	511211392	12	28"	3"	4*	F, M, IC	47 3/4"	13"	1 1/2"	1 3/4"	6 7/8	939.99

\*TOTAL AMMUNITION CAPACITY INCLUDES ONE ADDITIONAL SHELL IN THE CHAMBER

# SUPER X<sup>®</sup>3

## EXTRAORDINARY CYCLING SPEED.

HERE'S THE AUTOLOADING SHOTGUN THAT'S FAST ENOUGH TO PUT 12 SHELLS DOWN RANGE IN A MERE 1.442 SECONDS WITH ABSOLUTE RELIABILITY. IT'S JUST WHAT YOU WANT WHEN A FLURRY OF CLAYS ARE INBOUND ON YOUR STATION OR A COVEY OF QUAIL EXPLODE RIGHT AT YOUR FEET. THAT'S WHEN THE SUPER X<sup>®</sup>3 LETS YOU SHOW THE WORLD WHAT YOU CAN DO WITH A SHOTGUN AT YOUR SHOULDER.

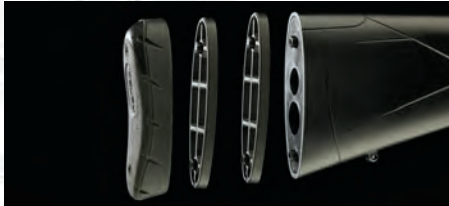

There is no reason to put up with a shotgun that does not fit you, because proper stock fit is critical to comfortable and accurate shooting. Most Super X<sup>®</sup>3 shotguns come with **LENGTH OF PULL SPACERS** that fit between the stock and the recoil pad, allowing easy adjustments to length of pull. When the length of pull is adjusted properly, you smoothly shoulder the gun with confidence and the "felt recoil" you experience is greatly diminished. Adjustments range from 13 3/4" to 14 3/4" on wood stocks and from 14 1/4" to 14 3/4" on synthetic stock models.



Getting pounded by recoil is a thing of the past with the **INFLEX TECHNOLOGY RECOIL PAD**. Specially shaped rib structures located inside the pad help direct and channel the recoil impulse, moving the comb down and away from your cheek to reduce "felt recoil" to very manageable levels, even when shooting heavy magnum loads. A hard heel insert on the pad makes mounting the Super X<sup>®</sup>3 snag-free.

### SHIM CAST ADJUSTMENT

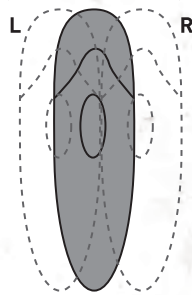

### SHIM COMB DROP ADJUSTMENT

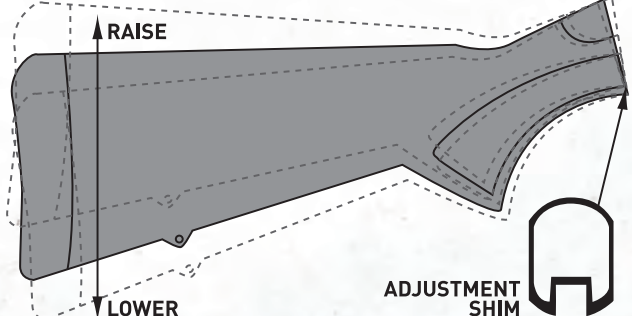

1-Neutral cast. Raises comb.

2-Neutral cast. Neutral comb.

3-Neutral cast. Lowers the comb.

1R/1L-Changes cast. Raises the comb.

2R/2L-Changes cast. Neutral comb.

3R/3L-Changes cast. Lowers the comb.

Every shooter is different, and no single stock design will perfectly fit every person. **MULTI-AXIS CAST/DROP SHIMS** on Super X<sup>®</sup>3 synthetic stock models allow you to easily adjust both cast on/cast off and drop at comb over a 1/4" range simply by inserting one of the six special shims between the receiver and the buttstock.



The **AMBIDEXTRIOUS SAFETY** button on the Super X<sup>®</sup>3 is located at the rear of the trigger guard and is easily reversible for both right- or left-handed shooters.



The **DROP-OUT TRIGGER GROUP** is easy to remove for cleaning and lubrication.



®



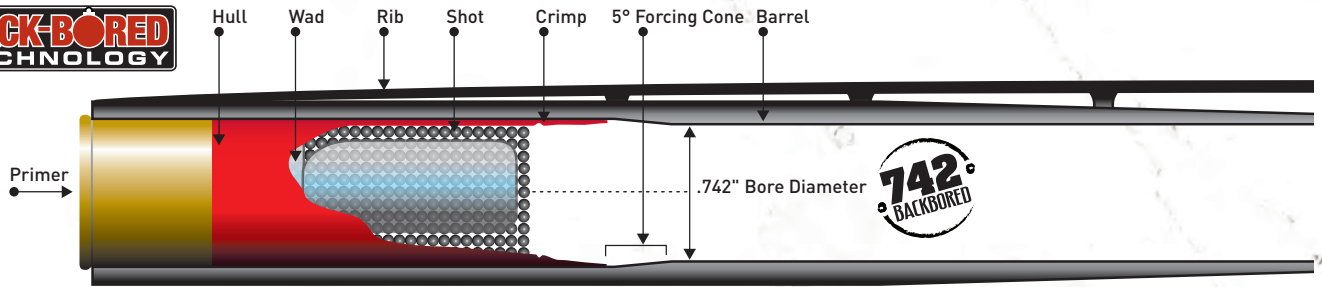

**BACK-BORED TECHNOLOGY** is based on extensive research and testing to find the secret to tighter, more consistent patterns. Instead of the traditional bore size of .729", this research shows the ideal 12 gauge interior diameter is .742". In 20 gauge barrels the ideal bore diameter is .630" instead of the standard .618". If the bore is any larger the gases will blow by the shot cup and reduce pellet velocity. If the bore is too tight the pellets are deformed as they pass through the forcing cone, causing poor ballistic performance.



**CHROME-PLATED CHAMBER AND BORE** are critical for today's steel or Hi-Density (HD) shot. Hard chrome makes the surfaces highly resistant to wear and gives you superior protection from rust and corrosion. That's why all smoothbore Super X<sup>®</sup>3 shotguns feature a hard-chromed chamber and bore.



**LOAD DIVERSITY** means a Super X<sup>®</sup>3 can reliably shoot them all, from light factory field shells to heavy magnum waterfowl and turkey loads. That's why the Super X3 has been proven as the most versatile autoloader on the range, in the marsh and in the field.



From the duck blind to the firing line, the **INVECTOR-PLUS CHOKE TUBE SYSTEM** is the world's most consistent. The Super X<sup>®</sup>3 comes with full, modified and improved cylinder flush-mounted choke tubes so your gun is ready for anything, right out of the box. Additional choke tubes are available at your local firearms dealer.

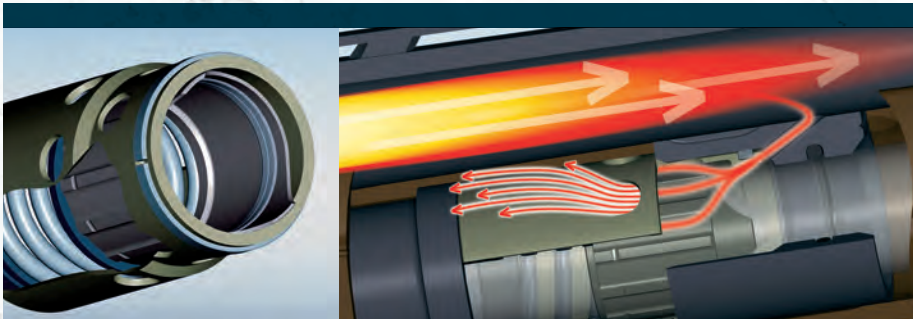

The **ACTIVE VALVE SYSTEM** automatically self-adjusts to allocate the exact gas pressure necessary to reliably cycle a wide range of loads commonly used for hunting or target shooting. When firing the heaviest magnum loads in 3 1/2" models, gases vent upward and a portion of them are vented forward out the Quadra-Vent™ ports in the forearm to help regulate bolt speed. Both 3" and 3 1/2" Super X<sup>®</sup>3 shotguns will reliably cycle even 1 1/8 oz., 2 3/4" light loads.



Excess gases from heavy loads are channeled through the forward **QUADRA-VENT™** ports for cleaner and more reliable operation.



# CLAYS AWAY. CHAMPION CLAY BUSTERS.

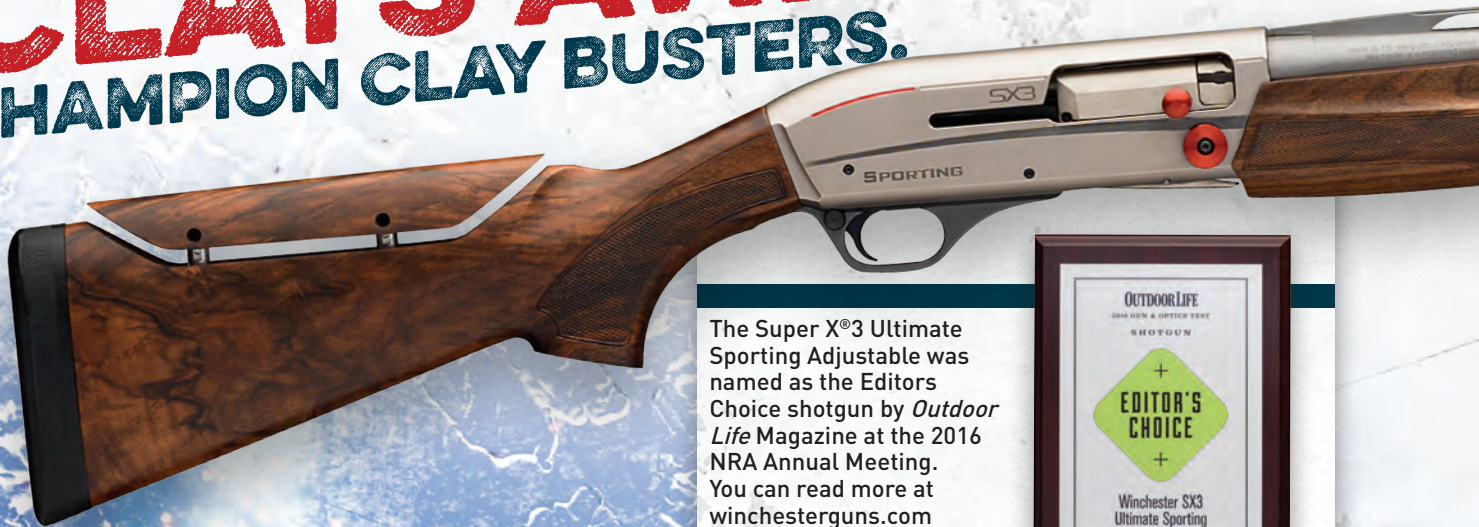

The Super X<sup>3</sup> Ultimate Sporting Adjustable was named as the Editors Choice shotgun by *Outdoor Life* Magazine at the 2016 NRA Annual Meeting. You can read more at [winchesterguns.com](http://winchesterguns.com)



# SXB<sup>®</sup>



T-WRENCH, LF, IM, M, IC, SK



## COMPOSITE SPORTING

- **SYNTHETIC STOCK** provides excellent grip
- **MATTE NICKEL-PLATED RECEIVER** is strong, lightweight aluminum alloy to reduce weight for a fast, easy swing
- **SIGNATURE RED BRILEY<sup>®</sup>** bolt handle, bolt release button and magazine cap weight system
- **BACK-BORED TECHNOLOGY** provides optimum shot patterns that are dense and even
- **PERMA-COTE GRAY FINISH PORTED BARREL WITH VENT RIB, TRU-GLO<sup>®</sup> FIBER-OPTIC SIGHT AND WHITE MID-BEAD** give you a clean sighting plane
- **HARD CHROME-PLATED CHAMBER AND BORE** make these surfaces highly resistant to wear and corrosion

- **EXTENDED SIGNATURE INVECTOR-PLUS CHOKE TUBES** offer consistent, reliable patterns
- **ACTIVE VALVE SYSTEM** cycles a wide variety of loads while reducing "felt recoil"
- **CAST/DROP SHIMS AND LENGTH OF PULL SPACERS** allow adjustments for a perfect fit
- **INFLEX TECHNOLOGY RECOIL PAD** directs "felt recoil" down and away from your cheek to reduce flinch and fatigue
- **AMBIDEXTROUS CROSSBOLT SAFETY** is easily reversible
- **DROP-OUT TRIGGER GROUP** allows for easy cleaning
- **RED ABS HARD-SIDE CASE** is included



## ULTIMATE SPORTING ADJUSTABLE

- **SATIN OIL FINISH GRADE II/III WALNUT STOCK WITH ADJUSTABLE COMB AND CUT CHECKERING** look elegant and provide the ultimate in functionality
- **MATTE NICKEL-PLATED RECEIVER** is strong, lightweight aluminum alloy to reduce weight for a fast, easy swing
- **SIGNATURE RED BRILEY®** bolt handle, bolt release button and magazine cap weight system
- **BACK-BORED TECHNOLOGY** provides optimum shot patterns that are dense and even
- **PERMA-COTE GRAY FINISH PORTED BARREL WITH VENT RIB, TRU-GLO® FIBER-OPTIC SIGHT AND WHITE MID-BEAD** give you a clean sighting plane

- **HARD CHROME-PLATED CHAMBER AND BORE** make these surfaces highly resistant to wear and corrosion
- **EXTENDED SIGNATURE INVECTOR-PLUS CHOKE TUBES** offer consistent, reliable patterns
- **ACTIVE VALVE SYSTEM** cycles a wide variety of loads while reducing "felt recoil"
- **PACHMAYR® DECELERATOR® RECOIL PAD** provides optimal protection against "felt recoil"
- **AMBIDEXTROUS CROSSBOLT SAFETY** is easily reversible
- **DROP-OUT TRIGGER GROUP** allows easy cleaning
- **RED ABS HARD-SIDE CASE** is included



## COMPOSITE SPORTING CARBON FIBER

- **SYNTHETIC STOCK WITH CARBON-FIBER FINISH** provides excellent grip with a modern aerospace look
- **MATTE NICKEL-PLATED RECEIVER** is strong, lightweight aluminum alloy to reduce weight for a fast, easy swing
- **SIGNATURE RED BRILEY®** bolt handle, bolt release button and magazine cap weight system
- **BACK-BORED TECHNOLOGY** provides optimum shot patterns that are dense and even
- **PERMA-COTE GRAY FINISH PORTED BARREL WITH VENT RIB, TRU-GLO® FIBER-OPTIC SIGHT AND WHITE MID-BEAD** give you a clean sighting plane
- **HARD CHROME-PLATED CHAMBER AND BORE** make these surfaces highly resistant to wear and corrosion

- **EXTENDED SIGNATURE INVECTOR-PLUS CHOKE TUBES** offer consistent, reliable patterns
- **ACTIVE VALVE SYSTEM** cycles a wide variety of loads while reducing "felt recoil"
- **CAST/DROP SHIMS AND LENGTH OF PULL SPACERS** allow adjustments for a perfect fit
- **INFLEX TECHNOLOGY RECOIL PAD** directs "felt recoil" down and away from your cheek to reduce flinch and fatigue
- **AMBIDEXTROUS CROSSBOLT SAFETY** is easily reversible
- **DROP-OUT TRIGGER GROUP WITH CARBON-FIBER FINISH** allows easy cleaning
- **RED ABS HARD-SIDE CASE** is included

ITEM NUMBER	GAUGE	BARREL LENGTH	CHAMBER	MAGAZINE CAPACITY	CHOKE TUBES INCLUDED	OVERALL LENGTH**	LENGTH OF PULL	DROP AT COMB	DROP AT HEEL	NOMINAL WT. (LBS.)	SUGGESTED RETAIL
<b>SX3 ULTIMATE SPORTING ADJUSTABLE</b>											
511174392	12	28"	2 3/4"	4*	LF, IM, M, IC, SK	49 1/4"	14 1/2"	1 1/2"	1 3/4"	7 3/8	\$1,869.99
511174393	12	30"	2 3/4"	4*	LF, IM, M, IC, SK	51 1/4"	14 1/2"	1 1/2"	1 3/4"	7 1/2	1,869.99
511174394	12	32"	2 3/4"	4*	LF, IM, M, IC, SK	53 1/4"	14 1/2"	1 1/2"	1 3/4"	7 5/8	1,869.99
<b>SX3 COMPOSITE SPORTING CARBON FIBER</b>											
511172392	12	28"	2 3/4"	4*	LF, IM, M, IC, SK	49"	14 1/4"	1 3/4"	2"	7 1/4	\$1,739.99
511172393	12	30"	2 3/4"	4*	LF, IM, M, IC, SK	51"	14 1/4"	1 3/4"	2"	7 3/8	1,739.99
511172394	12	32"	2 3/4"	4*	LF, IM, M, IC, SK	53"	14 1/4"	1 3/4"	2"	7 1/2	1,739.99
<b>SX3 COMPOSITE SPORTING</b>											
511173392	12	28"	2 3/4"	4*	LF, IM, M, IC, SK	49"	14 1/4"	1 3/4"	2"	7 1/4	\$1,679.99
511173393	12	30"	2 3/4"	4*	LF, IM, M, IC, SK	51"	14 1/4"	1 3/4"	2"	7 3/8	1,679.99
511173394	12	32"	2 3/4"	4*	LF, IM, M, IC, SK	53"	14 1/4"	1 3/4"	2"	7 1/2	1,679.99

\*TOTAL AMMUNITION CAPACITY INCLUDES ONE ADDITIONAL SHELL IN THE CHAMBER

\*\*OVERALL LENGTH DOES NOT INCLUDE CHOKE TUBE

# BIRD BUSTERS.

FILL YOUR BAG WITH BIRDS.



ITEM NUMBER	GAUGE	BARREL LENGTH	CHAMBER	MAGAZINE CAPACITY	CHOKE TUBES INCLUDED	OVERALL LENGTH	LENGTH OF PULL	DROP AT COMB	DROP AT HEEL	NOMINAL WT. (LBS.)	SUGGESTED RETAIL
<b>SX3 FIELD</b>											
511144691	20	26"	3"	4*	F, M, IC	47"	14 1/4"	1 3/8"	1 7/8"	6 3/8	\$1,139.99
511144692	20	28"	3"	4*	F, M, IC	49"	14 1/4"	1 3/8"	1 7/8"	6 1/2	1,139.99

\*TOTAL AMMUNITION CAPACITY INCLUDES ONE ADDITIONAL SHELL IN THE CHAMBER



F, M, IC



## FIELD

- **SATIN OIL FINISH WALNUT STOCK WITH CLASSIC CUT CHECKERING** improves grip and looks elegant
- **MATTE BLACK RECEIVER** is strong, lightweight aluminum alloy to reduce weight for easy carrying
- **BACK-BORED TECHNOLOGY** provides optimum shot patterns that are dense and even
- **VENT RIB** gives you a smooth, clean sighting plane and helps reduce weight
- **BRASS FRONT SIGHT BEAD** offers a fast, natural sight picture in a wide variety of lighting conditions

- **HARD CHROME-PLATED CHAMBER AND BORE** make these surfaces highly resistant to wear and corrosion
- **INVECTOR-PLUS CHOKE TUBES** offer consistent, reliable patterns
- **ACTIVE VALVE SYSTEM** cycles a wide variety of loads while reducing "felt recoil"
- **PACHMAYR® DECELERATOR® RECOIL PAD** provides optimal protection against "felt recoil"
- **AMBIDEXTROUS CROSSBOLT SAFETY** is easily reversible
- **DROP-OUT TRIGGER GROUP** allows for easy cleaning



F, M, IC



## FIELD COMPACT

- **COMPACT 13" LENGTH OF PULL** to fit smaller statured shooters
- **SATIN OIL FINISH WALNUT STOCK WITH CLASSIC CUT CHECKERING** improves grip and looks elegant
- **MATTE BLACK RECEIVER** is strong, lightweight aluminum alloy to reduce weight for easy carrying
- **BACK-BORED TECHNOLOGY** provides optimum shot patterns that are dense and even
- **VENT RIB** gives you a smooth, clean sighting plane and helps reduce weight
- **BRASS FRONT SIGHT BEAD** offers a fast, natural sight picture in a wide variety of lighting conditions

- **HARD CHROME-PLATED CHAMBER AND BORE** make these surfaces highly resistant to wear and corrosion
- **INVECTOR-PLUS CHOKE TUBES** offer consistent, reliable patterns
- **ACTIVE VALVE SYSTEM** cycles a wide variety of loads while reducing "felt recoil"
- **PACHMAYR® DECELERATOR® RECOIL PAD** provides optimal protection against "felt recoil"
- **AMBIDEXTROUS CROSSBOLT SAFETY** is easily reversible
- **DROP-OUT TRIGGER GROUP** allows for easy cleaning



ITEM NUMBER	GAUGE	BARREL LENGTH	CHAMBER	MAGAZINE CAPACITY	CHOKE TUBES INCLUDED	OVERALL LENGTH	LENGTH OF PULL	DROP AT COMB	DROP AT HEEL	NOMINAL WT. (LBS.)	SUGGESTED RETAIL
<b>SX3 FIELD COMPACT</b>											
511146690	20	24"	3"	4*	F, M, IC	43 3/4"	13"	1 5/8"	1 7/8"	6 1/4	\$1,139.99
511146691	20	26"	3"	4*	F, M, IC	45 3/4"	13"	1 5/8"	1 7/8"	6 3/8	1,139.99
511146692	20	28"	3"	4*	F, M, IC	47 3/4"	13"	1 5/8"	1 7/8"	6 1/2	1,139.99

\*TOTAL AMMUNITION CAPACITY INCLUDES ONE ADDITIONAL SHELL IN THE CHAMBER

# BUCK'N BIRD.

TAKE YOUR BEST SHOT AT BUCKS,  
BOARS AND BIRDS.



# SXB

	ITEM NUMBER	GAUGE	BARREL LENGTH	CHAMBER	MAGAZINE CAPACITY	CHOKE TUBES INCLUDED	OVERALL LENGTH	LENGTH OF PULL	DROP AT COMB	DROP AT HEEL	NOMINAL WT. (LBS.)	SUGGESTED RETAIL
<b>SX3 BLACK SHADOW</b>												
<b>NEW</b>	511123690	20	24"	3"	4*	F, M, IC	45"	14 1/4"	1 3/4"	2"	6 1/2	\$1,069.99
	511123691	20	26"	3"	4*	F, M, IC	47"	14 1/4"	1 3/4"	2"	6 5/8	1,069.99
	511123692	20	28"	3"	4*	F, M, IC	49"	14 1/4"	1 3/4"	2"	6 3/4	1,069.99
<b>SX3 CANTILEVER BUCK</b>												
	511147340	12	22"	3"	4**	1:28" RH Twist	43"	14 1/4"	1 3/4"	2"	7 3/4	\$1,149.99
	511147640	20	22"	3"	4**	1:24" RH Twist	43"	14 1/4"	1 3/4"	2"	7 1/2	1,199.99
<b>SX3 WATERFOWL HUNTER</b>												
	511155691	20	26"	3"	4*	F, M, IC	47"	14 1/4"	1 3/4"	2"	6 5/8	\$1,199.99
	511155692	20	28"	3"	4*	F, M, IC	49"	14 1/4"	1 3/4"	2"	6 3/4	1,199.99

\*TOTAL AMMUNITION CAPACITY INCLUDES ONE ADDITIONAL SHELL IN THE CHAMBER

\*\*MAGAZINE CAPACITY DEPENDS ON SHELL LENGTH. SOME SLUGS ARE LONGER THAN STANDARD 2 3/4" SHOT SHELLS.





- **SYNTHETIC STOCK WITH TEXTURED GRIPPING SURFACES** give your hands a sure, non-slip grip and the non-glare matte black finish won't spook wary game
- **BACK-BORED TECHNOLOGY** provides optimum shot patterns that are dense and even
- **INVECTOR-PLUS CHOKE TUBE SYSTEM** offers consistent patterns to match your situation
- **HARD CHROME-PLATED CHAMBER AND BORE** make these surfaces highly resistant to wear and corrosion
- **BRASS BEAD FRONT SIGHT** offers a fast, natural sight picture

- **SELF-ADJUSTING ACTIVE VALVE SYSTEM** cycles a wide variety of loads while reducing "felt recoil"
- **QUADRA-VENT™ PORTS** vent excess gases for cleaner operation
- **DROP-OUT TRIGGER GROUP** allows for easy cleaning
- **AMBIDEXTROUS CROSSBOLT SAFETY** is easily reversible
- **CAST/DROP SHIMS AND LENGTH OF PULL SPACERS** allow adjustments for a perfect fit
- **INFLEX TECHNOLOGY RECOIL PAD** directs "felt recoil" down and away from your cheek to reduce flinch and fatigue



- **SYNTHETIC STOCK WITH TEXTURED GRIPPING SURFACES** give your hands a sure, non-slip grip and the non-glare matte black finish won't spook wary game
- **RIFLED 22" BARREL** optimized for extreme accuracy with 2 3/4" and 3" sabots and slugs
- **MATTE BLACK RECEIVER** is strong, lightweight aluminum alloy for easy carrying
- **WEAVER®-STYLE CANTILEVER RAIL DESIGN** makes it easy to attach an electronic sight or conventional scope

- **TRUGLO® FIBER-OPTIC FRONT SIGHT** with adjustable rear sight gathers light for fast, quick pointing
- **SELF-ADJUSTING ACTIVE VALVE SYSTEM** cycles a wide variety of loads while reducing "felt recoil"
- **DROP-OUT TRIGGER GROUP** allows for easy cleaning
- **AMBIDEXTROUS CROSSBOLT SAFETY** is easily reversible
- **CAST/DROP SHIMS AND LENGTH OF PULL SPACERS** allow adjustments for a perfect fit
- **INFLEX TECHNOLOGY RECOIL PAD** directs "felt recoil" down and away from your cheek to reduce flinch and fatigue



- **SYNTHETIC STOCK WITH TEXTURED GRIPPING SURFACES** give your hands a sure, non-slip grip and the non-glare Mossy Oak® Shadow Grass Blades camo finish won't spook wary waterfowl
- **BACK-BORED TECHNOLOGY** provides optimum shot patterns that are dense and even
- **INVECTOR-PLUS CHOKE TUBE SYSTEM** offers consistent patterns to match your situation
- **HARD CHROME-PLATED CHAMBER AND BORE** make these surfaces highly resistant to corrosion and wear from steel shot
- **VENT RIB** gives you a smooth, clean sighting plane
- **TRUGLO® LONG BEAD™ FIBER-OPTIC FRONT SIGHT** offers a true, precise sight picture

- **ACTIVE VALVE GAS SYSTEM** cycles a wide variety of loads while reducing "felt recoil"
- **QUADRA-VENT™ PORTS** vent excess gases for cleaner operation
- **DROP-OUT TRIGGER GROUP** allows for easy cleaning
- **AMBIDEXTROUS CROSSBOLT SAFETY** is easily reversible
- **CAST/DROP SHIMS AND LENGTH OF PULL SPACERS** allow adjustments for perfect fit
- **INFLEX TECHNOLOGY RECOIL PAD** directs "felt recoil" down and away from your cheek to reduce flinch and fatigue

# TURKEY TIME.

## TWO ULTIMATE TURKEY GUNS.



**"THE SUPER X<sup>3</sup> LONG BEARD IS THE SWEETEST SHOOTING TURKEY GUN I'VE EVER OWNED! I'VE PUT IT THROUGH EVERY TEST IN EVERY CONDITION A TURKEY HUNTER CAN DREAM OF, AND IT ALWAYS PERFORMS!"**

— Mark Drury • *Drury Outdoors*

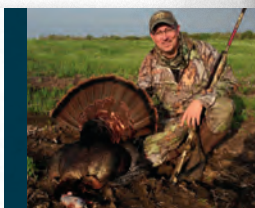

### **LONG BEARD™ XR™ IS LETHAL AT LONGER RANGES.**

If you think 40 yards is as far as you can take a trophy tom, think again. With Winchester® Long Beard® XR® and its new Shot-Lok® Technology, your effective range can increase by 20 to 30 yards and still deliver devastating, one-shot one-turkey performance.



### EXTRA-FULL TURKEY CHOKE TUBE

A tight, dense pattern of heavy shot is critical for taking turkeys. You get an Invector-Plus Extra-Full Turkey choke tube standard with the Super X®3 NWTf® Cantilever Turkey shotgun. The knurled friction band makes it easy to install or remove and the camo front band won't give you away to a sharp-eyed tom.



## NWTf® CANTILEVER TURKEY

- **SYNTHETIC STOCK WITH TEXTURED GRIPPING SURFACES** give your hands a sure, non-slip grip and the non-glare Mossy Oak® Break-Up Country® camo finish won't spook wary turkeys
- **BACK-BORED TECHNOLOGY** provides optimum shot patterns that are dense and even
- **INVECTOR-PLUS EXTRA-FULL TURKEY EXTENDED CHOKE TUBE** with Mossy Oak® Break-Up Country® camo front band produces a tight, tom-busting pattern
- **24" BARREL** is easy to swing in tight brush
- **HARD CHROME-PLATED CHAMBER AND BORE** make these surfaces highly resistant to wear and corrosion

- **TRUGLO® FIBER-OPTIC FRONT SIGHT WITH ADJUSTABLE REAR SIGHT** gathers light for quick target acquisition
- **WEAVER®-STYLE CANTILEVER RAIL DESIGN** makes it easy to attach an electronic sight or conventional scope
- **QUADRA-VENT™ PORTS** vent excess gases for cleaner operation
- **DROP-OUT TRIGGER GROUP** allows for easy cleaning
- **AMBIDEXTROUS CROSSBOLT SAFETY** is easily reversible
- **CAST/DROP SHIMS AND LENGTH OF PULL SPACERS** allow adjustments for perfect fit
- **INFLEX TECHNOLOGY RECOIL PAD** directs "felt recoil" down and away from your cheek to reduce flinch and fatigue

### LONG BEARD™ CHOKE TUBE

Aggressively avid turkey hunters will go to great lengths to tag that trophy tom. The Winchester Super X®3 Long Beard™ model features an extended Extra-Full Turkey tube with a fluted body, knurled friction ring and camo front band. It's designed to extract every bit of potential from Winchester's® Long Beard™ XR™ turkey ammunition.



## LONG BEARD™

- **SYNTHETIC PISTOL GRIP STOCK WITH TEXTURED GRIPPING SURFACES** give your hands a sure, non-slip grip and the non-glare Mossy Oak® Break-Up Country® finish won't spook wary turkeys
- **THREE INTERCHANGEABLE COMB INSERTS AND THREE RECOIL PAD OPTIONS** let you fine tune the shotgun's fit to match your shooting style
- **BACK-BORED TECHNOLOGY** provides optimum shot patterns that are dense and even
- **INVECTOR-PLUS BRILEY® EXTRA-FULL LONG BEARD™ EXTENDED CHOKE TUBE** is optimized for Winchester® Long Beard™ XR™ ammunition to produce a tight, tom-busting pattern

- **24" BARREL** is easy to swing in tight brush
- **HARD CHROME-PLATED CHAMBER AND BORE** make these surfaces highly resistant to wear and corrosion
- **TRUGLO® FIBER-OPTIC FRONT SIGHT WITH ADJUSTABLE REAR SIGHT** gathers light for quick target acquisition
- **WEAVER®-STYLE CANTILEVER RAIL DESIGN** makes it easy to attach an electronic sight or conventional scope
- **QUADRA-VENT™ PORTS** vent excess gases for cleaner operation
- **DROP-OUT TRIGGER GROUP** allows for easy cleaning
- **AMBIDEXTROUS CROSSBOLT SAFETY** is easily reversible

ITEM NUMBER	GAUGE	BARREL LENGTH	CHAMBER	MAGAZINE CAPACITY	CHOKE TUBES INCLUDED	OVERALL LENGTH**	LENGTH OF PULL	DROP AT COMB	DROP AT HEEL	NOMINAL WT. (LBS.)	SUGGESTED RETAIL
<b>SX3 NWTf CANTILEVER TURKEY</b>											
511169290	12	24"	3 1/2"	4*	X-FULL TURKEY	45"	14 1/4"	1 3/4"	2"	7 1/2	\$1,199.99
511169690	20	24"	3"	4*	X-FULL TURKEY	45"	14 1/4"	1 3/4"	2"	7 1/8	1,199.99
<b>SX3 LONG BEARD</b>											
511168290	12	24"	3 1/2"	4*	LONG BEARD	45"	14 1/4"	1 3/4"	2"	7 1/2	\$1,269.99

\*TOTAL AMMUNITION CAPACITY INCLUDES ONE ADDITIONAL SHELL IN THE CHAMBER \*\*OVERALL LENGTH DOES NOT INCLUDE CHOKE TUBE

# SUPER X<sup>®</sup> PUMP

## FASTEST PUMP ON THE PLANET.

NOTHING ELSE COMES CLOSE TO THE SOUND AND FEEL OF SHUCKING A SHELL IN A TOP-QUALITY WINCHESTER SUPER X<sup>®</sup> PUMP SHOTGUN. AS A PUMP LOVER YOU KNOW THE RELIABILITY OF A PUMP CAN'T BE BEAT. THE SMOOTHNESS THAT COMES FROM THE SUPER X PUMP SHOTGUN'S INERTIA-ASSISTED ACTION CYCLES SO FAST, YOU'LL THINK IT'S AN AUTOLOADER.

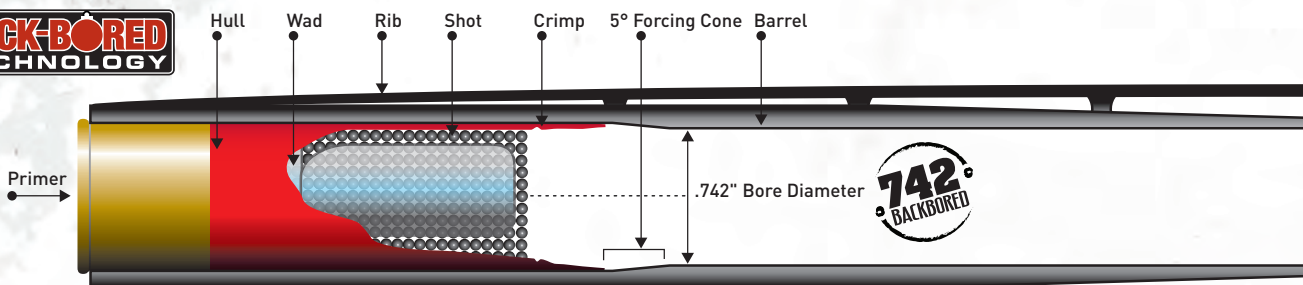

**BACK-BORED TECHNOLOGY** is based on extensive research and testing to find the secret to tighter, more consistent patterns. Instead of the traditional bore size of .729", this research shows the ideal 12 gauge interior diameter is .742". In 20 gauge barrels the ideal bore diameter is .630" instead of the standard .618". If the bore is any larger the gases will blow by the shot cup and reduce pellet velocity. If the bore is too tight the pellets are deformed as they pass through the forcing cone, causing poor ballistic performance.



From the duck blind to the firing line, the **INVECTOR-PLUS CHOKE TUBE SYSTEM** is the world's most consistent. The Super X<sup>®</sup> Pump comes with full, modified and improved cylinder flush-mounted choke tubes so your gun is ready for anything, right out of the box. Additional choke tubes are available at your local firearms dealer.



**HARD CHROME-PLATED CHAMBER AND BORE** are critical for today's steel or Hi-Density (HD) shot. Hard chrome makes the surfaces highly resistant to wear and gives you superior protection from rust and corrosion. That's why all smoothbore Super X<sup>®</sup> Pump shotguns feature a hard-chromed chamber and bore.



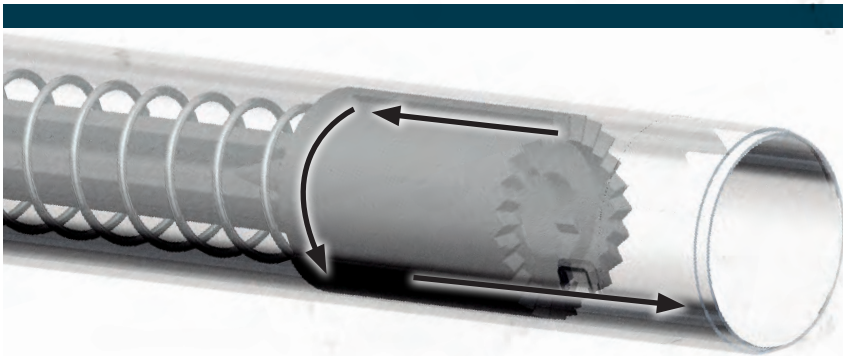

**SPEED-PLUG SYSTEM** lets you remove the three-shot adaptor with your fingers. Just remove the magazine cap, push on the spring retainer holding the spring in place, twist and remove the adaptor. It's a trouble-free design that lets you "pull the plug" in mere seconds without any tools.



The **CROSSBOLT SAFETY** button on the Super X<sup>®</sup> Pump is located on the front of the trigger guard for easy access, even when you're wearing heavy waterfowling gloves.

**DROP-OUT TRIGGER GROUP** lets you remove one pin and pull the complete trigger system out for cleaning, lubrication and inspection. It's an easy way to keep your Super X<sup>®</sup> Pump shotgun in top shape, regardless of nasty weather or gritty shooting conditions.



The Super X<sup>®</sup> Pump has the best recoil pad ever put on a shotgun. Directional rib structures inside the **INFLEX TECHNOLOGY RECOIL PAD** help channel the recoil impulse by moving the comb down and away from your cheek. The pad's smooth textured surface makes shouldering the Super X Pump snag free regardless of what clothing you're wearing.



Four massive **ROTARY BOLT LUGS** provide support, strength and solid lockup in the barrel of the lightning-fast Super X<sup>®</sup> Pump. Under recoil, the mass of your body slows the rearward travel of the shotgun, while the inertial motion of the bolt, slide and forearm continue cycling the action to give you a head start ejecting the fired shell. Robust dual steel action guide bars eliminate the twisting and binding that waste time and energy when cycling the action.

**BLACK CHROME FINISH** on the bolt, barrel, slide, action bars and other parts protects better than conventional bluing and stands up to years of wear and harsh conditions.



**DURABLE E-COATING** on the magazine tube helps protect it from wear and corrosion to keep it looking sharp for years to come.

# SXP<sup>®</sup>

**FEEL TRAPPED.**  
GET READY TO SHATTER YOUR  
COMPETITIONS' CONFIDENCE.



**SXP**<sup>®</sup>



## TRAP

- **SATIN FINISHED STOCK WITH A HIGH PROFILE TRAP COMB** and forearm with traditional checkering provide a sure grip when the trapshooting action gets fast and furious
- **BACK-BORED TECHNOLOGY** provides optimum shot patterns, even from the 27 yard line
- **INVECTOR-PLUS CHOKE TUBE SYSTEM** offers consistent patterns to match your shooting situation
- **HARD CHROME-PLATED CHAMBER AND BORE** make surfaces highly resistant to wear and corrosion from thousands of shells
- **BLACK CHROME PROTECTION** on the bolt and other components lasts longer than traditional bluing

- **5/16" TRAP RIB WITH TRUGLO® FIBER-OPTIC FRONT SIGHT AND AN IVORY MID-BEAD** produce a crisp sight picture on both rising and crossing targets
- **3-SHOT ADAPTOR WITH SPEED-PLUG SYSTEM** is easily removed without tools
- **DROP-OUT TRIGGER GROUP** allows for easy cleaning
- **CROSSBOLT SAFETY** is easily operated
- **INFLEX TECHNOLOGY RECOIL PAD** directs "felt recoil" down and away from your cheek to help reduce flinch and fatigue, especially important when you're going for 100 straight targets



## TRAP COMPACT

- **SATIN FINISHED STOCK WITH A HIGH PROFILE TRAP COMB** and forearm with traditional checkering provide a sure grip when the trapshooting action gets fast and furious
- **COMPACT 13" LENGTH OF PULL BUTTSTOCK** makes it an ideal shotgun for younger shooters or those of smaller stature
- **BACK-BORED TECHNOLOGY** provides optimum shot patterns, even from the 27 yard line
- **INVECTOR-PLUS CHOKE TUBE SYSTEM** offers consistent patterns to match your shooting situation
- **HARD CHROME-PLATED CHAMBER AND BORE** make surfaces highly resistant to wear and corrosion from thousands of shells
- **BLACK CHROME PROTECTION** on the bolt and other components lasts longer than traditional bluing

- **5/16" TRAP RIB WITH TRUGLO® FIBER-OPTIC FRONT SIGHT AND AN IVORY MID-BEAD** produce a crisp sight picture on both rising and crossing targets
- **3-SHOT ADAPTOR WITH SPEED-PLUG SYSTEM** is easily removed without tools
- **DROP-OUT TRIGGER GROUP** allows for easy cleaning
- **CROSSBOLT SAFETY** is easily operated
- **INFLEX TECHNOLOGY RECOIL PAD** directs "felt recoil" down and away from your cheek to help reduce flinch and fatigue, especially important when you're going for 100 straight targets

ITEM NUMBER	GAUGE	BARREL LENGTH	CHAMBER	MAGAZINE CAPACITY	CHOKE TUBES INCLUDED	OVERALL LENGTH	LENGTH OF PULL	DROP AT COMB	DROP AT HEEL	NOMINAL WT. (LBS.)	SUGGESTED RETAIL
<b>SXP TRAP</b>											
512296393	12	30"	3"	4*	F, IM, M	51"	14 1/4"	1 3/8"	2 1/8"	7 1/2	\$479.99
512296394	12	32"	3"	4*	F, IM, M	53"	14 1/4"	1 3/8"	2 1/8"	7 5/8	479.99
<b>SXP TRAP COMPACT</b>											
512297392	12	28"	3"	4*	F, IM, M	47 3/4"	13"	1 3/8"	2 1/8"	7 1/4	\$479.99
512297393	12	30"	3"	4*	F, IM, M	49 3/4"	13"	1 3/8"	2 1/8"	7 3/8	479.99

\*TOTAL AMMUNITION CAPACITY INCLUDES ONE ADDITIONAL SHELL IN THE CHAMBER

# FASTER AFIELD.

NO BIRD FLIES TOO FAST FOR  
THE SUPER X<sup>®</sup> PUMP.



# SXP



ITEM NUMBER	GAUGE	BARREL LENGTH	CHAMBER	MAGAZINE CAPACITY	CHOKE TUBES INCLUDED	OVERALL LENGTH	LENGTH OF PULL	DROP AT COMB	DROP AT HEEL	NOMINAL WT. (LBS.)	SUGGESTED RETAIL
<b>SXP FIELD</b>											
512266391	12	26"	3"	4*	F, M, IC	46 3/4"	14"	1 5/8"	2"	7	\$399.99
512266392	12	28"	3"	4*	F, M, IC	48 3/4"	14"	1 5/8"	2"	7 1/8	399.99
512266691	20	26"	3"	5*	F, M, IC	46 3/4"	14"	1 5/8"	2"	6 3/4	429.99
512266692	20	28"	3"	5*	F, M, IC	48 3/4"	14"	1 5/8"	2"	6 7/8	429.99
<b>SXP FIELD COMPACT</b>											
512287390	12	24"	3"	4*	F, M, IC	43 1/2"	13"	1 5/8"	2"	6 1/2	\$399.99
512271391	12	26"	3"	4*	F, M, IC	45 1/2"	13"	1 5/8"	2"	6 5/8	399.99
512271392	12	28"	3"	4*	F, M, IC	47 1/2"	13"	1 5/8"	2"	6 3/4	399.99
512271690	20	24"	3"	5*	F, M, IC	43 1/2"	13"	1 5/8"	2"	6 3/8	429.99
512271691	20	26"	3"	5*	F, M, IC	45 1/2"	13"	1 5/8"	2"	6 1/2	429.99
512271692	20	28"	3"	5*	F, M, IC	47 1/2"	13"	1 5/8"	2"	6 5/8	429.99

\*TOTAL AMMUNITION CAPACITY INCLUDES ONE ADDITIONAL SHELL IN THE CHAMBER





- **SATIN FINISHED STOCK AND FOREARM** with traditional checkering provide a sure grip when the hunting action gets hot
- **BACK-BORED TECHNOLOGY** provides optimum shot patterns that are dense and even
- **3" CHAMBER** gives you the added range to knock down game with heavy hunting loads
- **INVECTOR-PLUS CHOKE TUBE SYSTEM** offers consistent patterns to match your game and situation
- **HARD CHROME-PLATED CHAMBER AND BORE** make surfaces highly resistant to wear and corrosion



F, M, IC



## FIELD

- **BLACK CHROME PROTECTION** on the bolt and other components lasts longer than traditional bluing
- **BRASS FRONT SIGHT BEAD** offers a fast, natural sight picture
- **3-SHOT ADAPTOR WITH SPEED-PLUG SYSTEM** is easily removed without tools
- **DROP-OUT TRIGGER GROUP** allows for easy cleaning
- **CROSSBOLT SAFETY** is easily operated
- **INFLEX TECHNOLOGY RECOIL PAD** directs "felt recoil" down and away from your cheek to reduce flinch and fatigue



- **COMPACT 13" LENGTH OF PULL** to better fit smaller statured shooters
- **SATIN FINISHED STOCK AND FOREARM** with traditional checkering provide a sure grip when the hunting action gets hot
- **BACK-BORED TECHNOLOGY** provides optimum shot patterns that are dense and even
- **3" CHAMBER** gives you the added range to knock down game with heavy hunting loads
- **INVECTOR-PLUS CHOKE TUBE SYSTEM** offers consistent patterns to match your game and situation



F, M, IC



## FIELD COMPACT

- **HARD CHROME-PLATED CHAMBER AND BORE** make surfaces highly resistant to wear and corrosion
- **BLACK CHROME PROTECTION** on the bolt and other components lasts longer than traditional bluing
- **BRASS FRONT SIGHT BEAD** offers a fast, natural sight picture
- **3-SHOT ADAPTOR WITH SPEED-PLUG SYSTEM** is easily removed without tools
- **DROP-OUT TRIGGER GROUP** allows for easy cleaning
- **CROSSBOLT SAFETY** is easily operated
- **INFLEX TECHNOLOGY RECOIL PAD** directs "felt recoil" down and away from your cheek to reduce flinch and fatigue

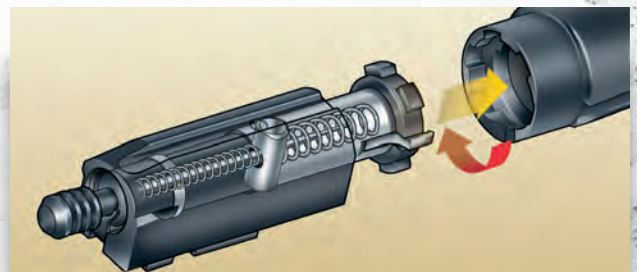

Four massive **ROTARY BOLT LUGS** provide support, strength and solid lockup in the barrel of the lightning-fast Super X® Pump shotgun. Under recoil, the mass of your body slows the rearward travel of the shotgun, while the inertial motion of the bolt, slide and forearm continue cycling the action to give you a head start ejecting the fired shell. Robust dual steel action guide bars eliminate the twisting and binding that waste time and energy when cycling the action.



**"IF IT'S A HOT SUMMER EARLY SEASON SOUTH DAKOTA GOOSE HUNT OR A BITTER COLD LATE WINTER ROOSTER HUNT, I PUT MY SHOTGUNS THROUGH HELL. THE WINCHESTER SUPER X® PUMP HAS ALWAYS PERFORMED WITHOUT A JAM. ... (AFTER) FIVE YEARS... IT OPERATES PERFECTLY, JUST LIKE THE DAY I BOUGHT IT."**

— Benny Spies • *Gun It with Benny Spies*

# BIRD HUNTERS.

## ALL THE BIRDS. ALL THE TIME.



The receiver on the Winchester Super X® Pump Universal Hunter shotgun is drilled and tapped for optional Winchester scope bases and rings. See the full line of bases and rings on page 75.

# SXP

ITEM NUMBER	GAUGE	BARREL LENGTH	CHAMBER	MAGAZINE CAPACITY	CHOKE TUBES INCLUDED	OVERALL LENGTH	LENGTH OF PULL	DROP AT COMB	DROP AT HEEL	NOMINAL WT. (LBS.)	SUGGESTED RETAIL
<b>SXP WATERFOWL HUNTER</b>											
512270291	12	26"	3 1/2"	4*	F, M, IC	47"	13 3/4"	1 5/8"	2"	6 7/8	\$499.99
512270292	12	28"	3 1/2"	4*	F, M, IC	49"	13 3/4"	1 5/8"	2"	7	499.99
512270391	12	26"	3"	4*	F, M, IC	46 1/2"	13 3/4"	1 5/8"	2"	6 3/4	459.99
512270392	12	28"	3"	4*	F, M, IC	48 1/2"	13 3/4"	1 5/8"	2"	6 7/8	459.99
512270691	20	26"	3"	5*	F, M, IC	46 1/2"	13 3/4"	1 5/8"	2"	6 1/2	499.99
512270692	20	28"	3"	5*	F, M, IC	48 1/2"	13 3/4"	1 5/8"	2"	6 5/8	499.99

\*TOTAL AMMUNITION CAPACITY INCLUDES ONE ADDITIONAL SHELL IN THE CHAMBER



F, M, IC

**BACK-BORED TECHNOLOGY**

**TRUGLO**

## WATERFOWL HUNTER

- **SYNTHETIC STOCK WITH TEXTURED GRIPPING SURFACES** give your hands a sure, non-slip grip and the non-glare Mossy Oak® Shadow Grass Blades finish won't spook wary waterfowl
- **BACK-BORED TECHNOLOGY** provides optimum shot patterns that are dense and even
- **3" AND 3 1/2" CHAMBER** models give you the magnum advantage to reach out for long-range waterfowl
- **INVECTOR-PLUS CHOKE TUBE SYSTEM** offers consistent patterns to match your game and situation
- **HARD CHROME-PLATED CHAMBER AND BORE** make these surfaces highly resistant to wear and corrosion

- **BLACK CHROME PROTECTION** on the bolt and other components lasts longer than traditional bluing
- **TRUGLO® LONG BEAD™ FIBER-OPTIC FRONT SIGHT** offers a true, precise sight picture
- **3-SHOT ADAPTOR WITH SPEED-PLUG SYSTEM** is easily removed without tools
- **ROTARY BOLT** with four massive lugs provides strength, support and solid lockup
- **DROP-OUT TRIGGER GROUP** allows for easy cleaning
- **CROSSBOLT SAFETY** is easily operated, even with gloves
- **INFLEX TECHNOLOGY RECOIL PAD** directs "felt recoil" down and away from your cheek to reduce flinch and fatigue



F, M, IC

**BACK-BORED TECHNOLOGY**

**TRUGLO**

## UNIVERSAL HUNTER

- **SYNTHETIC STOCK WITH TEXTURED GRIPPING SURFACES** give your hands a sure, non-slip grip and the non-glare Mossy Oak® Break-Up Country® camo finish won't spook wary game
- **BACK-BORED TECHNOLOGY** provides optimum shot patterns that are dense and even
- **3" AND 3 1/2" CHAMBER** models give you the magnum advantage to reach out for long-range waterfowl
- **INVECTOR-PLUS CHOKE TUBE SYSTEM** offers consistent patterns to match your game and situation
- **HARD CHROME-PLATED CHAMBER AND BORE** make these surfaces highly resistant to wear and corrosion
- **ALLOY RECEIVER** is drilled and tapped for scope bases

- **BLACK CHROME PROTECTION** on the bolt and other components lasts longer than traditional bluing
- **TRUGLO® LONG BEAD™ FIBER-OPTIC FRONT SIGHT** offers a true, precise sight picture
- **3-SHOT ADAPTOR WITH SPEED-PLUG SYSTEM** is easily removed without tools
- **ROTARY BOLT** with four massive lugs provides strength, support and solid lockup
- **DROP-OUT TRIGGER GROUP** allows for easy cleaning
- **CROSSBOLT SAFETY** is easily operated, even with gloves
- **INFLEX TECHNOLOGY RECOIL PAD** directs "felt recoil" down and away from your cheek to reduce flinch and fatigue

ITEM NUMBER	GAUGE	BARREL LENGTH	CHAMBER	MAGAZINE CAPACITY	CHOKE TUBES INCLUDED	OVERALL LENGTH	LENGTH OF PULL	DROP AT COMB	DROP AT HEEL	NOMINAL WT. (LBS.)	SUGGESTED RETAIL
<b>SXP UNIVERSAL HUNTER</b>											
512321290	12	24"	3 1/2"	4*	F, M, IC	45"	13 3/4"	1 5/8"	2"	6 3/4	\$509.99
512321291	12	26"	3 1/2"	4*	F, M, IC	47"	13 3/4"	1 5/8"	2"	6 7/8	509.99
512321292	12	28"	3 1/2"	4*	F, M, IC	49"	13 3/4"	1 5/8"	2"	7	509.99
512321390	12	24"	3"	4*	F, M, IC	44 1/2"	13 3/4"	1 5/8"	2"	6 5/8	469.99
512321391	12	26"	3"	4*	F, M, IC	46 1/2"	13 3/4"	1 5/8"	2"	6 3/4	469.99
512321392	12	28"	3"	4*	F, M, IC	48 1/2"	13 3/4"	1 5/8"	2"	6 7/8	469.99
512321690	20	24"	3"	5*	F, M, IC	44 1/2"	13 3/4"	1 5/8"	2"	6 3/8	509.99
512321691	20	26"	3"	5*	F, M, IC	46 1/2"	13 3/4"	1 5/8"	2"	6 1/2	509.99
512321692	20	28"	3"	5*	F, M, IC	48 1/2"	13 3/4"	1 5/8"	2"	6 5/8	509.99

\*TOTAL AMMUNITION CAPACITY INCLUDES ONE ADDITIONAL SHELL IN THE CHAMBER

# STAY WITH THE SHADOWS.

YOU'RE READY TO BRING  
HOME A TROPHY.



The receiver on the Winchester Super X® Pump Black Shadow Deer shotgun is drilled and tapped for Winchester scope bases and rings. See the full line of bases and rings on page 75.



## BLACK SHADOW®

- **SYNTHETIC STOCK WITH TEXTURED GRIPPING SURFACES** give your hands a sure, non-slip grip and the non-glare matte black finish won't spook wary game
- **BACK-BORED TECHNOLOGY** provides optimum shot patterns that are dense and even
- **3" AND 3 1/2" CHAMBER** 12 gauge models give you the magnum advantage to reach out for long-range game
- **INVECTOR-PLUS CHOKE TUBE SYSTEM** offers consistent patterns to match your game and situation
- **HARD CHROME-PLATED CHAMBER AND BORE** make these surfaces highly resistant to wear and corrosion

- **BLACK CHROME PROTECTION** on the bolt and other components lasts longer than traditional bluing
- **BRASS FRONT SIGHT BEAD** offers a fast, natural sight picture
- **3-SHOT ADAPTOR WITH SPEED-PLUG SYSTEM** is easily removed without tools
- **ROTARY BOLT** with four massive lugs provides strength and solid lockup
- **DROP-OUT TRIGGER GROUP** allows for easy cleaning
- **CROSSBOLT SAFETY** is easily operated, even with gloves
- **INFLEX TECHNOLOGY RECOIL PAD** directs "felt recoil" down and away from your cheek to reduce flinch and fatigue



## BLACK SHADOW® DEER

- **SYNTHETIC STOCK WITH TEXTURED GRIPPING SURFACES** give your hands a sure, non-slip grip and the non-glare matte black finish won't spook wary game
- **22" FULLY-RIFLED BARREL** is designed to provide optimum accuracy with modern sabots and slugs
- **3" CHAMBER** gives you the ability to reach out for challenging shots
- **BLACK CHROME PROTECTION** on the bolt and other components lasts longer than traditional bluing
- **TRUGLO® FIBER-OPTIC FRONT SIGHT AND ADJUSTABLE REAR SIGHT** offer a fast, natural sight picture

- **ALLOY RECEIVER** is drilled and tapped for scope bases
- **3-SHOT ADAPTOR WITH SPEED-PLUG SYSTEM** is easily removed without tools
- **ROTARY BOLT** with four massive lugs provides strength, support and solid lockup
- **DROP-OUT TRIGGER GROUP** allows for easy cleaning
- **CROSSBOLT SAFETY** is easily operated, even with gloves
- **INFLEX TECHNOLOGY RECOIL PAD** directs "felt recoil" down and away from your cheek

	ITEM NUMBER	GAUGE	BARREL LENGTH	CHAMBER	MAGAZINE CAPACITY	CHOKE TUBES INCLUDED	OVERALL LENGTH	LENGTH OF PULL	DROP AT COMB	DROP AT HEEL	NOMINAL WT. (LBS.)	SUGGESTED RETAIL
<b>SXP BLACK SHADOW</b>												
<b>NEW</b>	512251290	12	24"	3 1/2"	4*	F, M, IC	44 1/2"	13 3/4"	1 5/8"	2"	6 3/4	\$399.99
	512251291	12	26"	3 1/2"	4*	F, M, IC	47"	13 3/4"	1 5/8"	2"	6 7/8	399.99
	512251292	12	28"	3 1/2"	4*	F, M, IC	49"	13 3/4"	1 5/8"	2"	7	399.99
<b>NEW</b>	512251390	12	24"	3"	4*	F, M, IC	44 1/2"	13 3/4"	1 5/8"	2"	6 3/4	379.99
	512251391	12	26"	3"	4*	F, M, IC	46 1/2"	13 3/4"	1 5/8"	2"	6 3/4	379.99
	512251392	12	28"	3"	4*	F, M, IC	48 1/2"	13 3/4"	1 5/8"	2"	6 7/8	379.99
<b>NEW</b>	512251690	20	24"	3"	5*	F, M, IC	44 1/2"	13 3/4"	1 5/8"	2"	6 1/2	399.99
	512251691	20	26"	3"	5*	F, M, IC	46 1/2"	13 3/4"	1 5/8"	2"	6 1/2	399.99
	512251692	20	28"	3"	5*	F, M, IC	48 1/2"	13 3/4"	1 5/8"	2"	6 5/8	399.99
<b>SXP BLACK SHADOW DEER</b>												
	512261340	12	22"	3"	4**	1:35" RH Twist	43"	13 3/4"	1 5/8"	2"	6 7/8	\$519.99
<b>NEW</b>	512261640	20	22"	3"	5**	1:24" RH Twist	43"	13 3/4"	1 5/8"	2"	6 5/8	549.99

\*TOTAL AMMUNITION CAPACITY INCLUDES ONE ADDITIONAL SHELL IN THE CHAMBER  
 \*\*MAGAZINE CAPACITY DEPENDS ON SHELL LENGTH. SOME SLUGS ARE LONGER THAN STANDARD 2 3/4" SHOT SHELLS.

# GRIP & RIP.

TAKE YOUR NEXT HUNT TO THE EXTREME.



Two user-interchangeable combs and height adjust spacers let you tune comb height on your SXP® Extreme Deer for perfect eye-to-sight alignment with your choice of sighting systems.



# SXP

ITEM NUMBER	GAUGE	BARREL LENGTH	CHAMBER	MAGAZINE CAPACITY	RATE OF TWIST	OVERALL LENGTH	LENGTH OF PULL	DROP AT COMB	DROP AT HEEL	NOMINAL WT. (LBS.)	SUGGESTED RETAIL
<b>SXP EXTREME DEER</b>											
512312340	12	22"	3"	4**	1:35" RH Twist	43"	13 3/4"	1 3/4"	2"	7	\$559.99
<b>SXP EXTREME DEER HUNTER</b>											
512313240	12	22"	3"	4**	1:35" RH Twist	43"	13 3/4"	1 3/4"	2"	7	\$619.99

\*TOTAL AMMUNITION CAPACITY INCLUDES ONE ADDITIONAL SHELL IN THE CHAMBER

\*\*MAGAZINE CAPACITY DEPENDS ON SHELL LENGTH. SOME SLUGS ARE LONGER THAN STANDARD 2 3/4" SHOT SHELLS.



The receivers on both Winchester Super X® Pump Extreme Deer shotgun models are drilled and tapped for Winchester scope bases and rings, allowing you to easily attach an optional scope or electronic sight to fully utilize the incredible accuracy of today's shotgun slug ammo. See the full line of bases and rings on page 75.



TRUGLO

## EXTREME DEER

- **SYNTHETIC PISTOL GRIP STOCK WITH TEXTURED GRIPPING SURFACES** give your hands a sure, non-slip grip and the non-glare matte black finish won't spook wary game
- **TWO INTERCHANGEABLE COMB PIECES** allow you to fine-tune drop at comb for use with iron, electronic or optical sights
- **TWO INTERCHANGEABLE LENGTH OF PULL SPACERS** allow you to fine-tune length of pull for a perfect stock fit
- **22" FULLY-RIFLED BARREL** is designed to provide optimum accuracy with modern sabots and slugs
- **3" CHAMBER** gives you the ability to reach out for challenging shots
- **BLACK CHROME PROTECTION** on the bolt and other components lasts longer than traditional bluing
- **TRUGLO® FIBER-OPTIC FRONT SIGHT AND ADJUSTABLE REAR SIGHT** offer a fast, natural sight picture
- **ALLOY RECEIVER** is drilled and tapped for scope bases
- **3-SHOT ADAPTOR WITH SPEED-PLUG SYSTEM** is easily removed without tools
- **ROTARY BOLT** with four massive lugs provides strength, support and solid lockup
- **DROP-OUT TRIGGER GROUP** allows for easy cleaning
- **CROSSBOLT SAFETY** is easily operated, even with gloves
- **INFLEX TECHNOLOGY RECOIL PAD** directs "felt recoil" down and away from your cheek



TRUGLO

## EXTREME DEER HUNTER

- **SYNTHETIC PISTOL GRIP STOCK WITH TEXTURED GRIPPING SURFACES** give your hands a sure, non-slip grip and the Mossy Oak® Break-Up Country® camo finish won't spook wary game
- **TWO INTERCHANGEABLE COMB PIECES** allow you to fine-tune drop at comb for use with iron, electronic or optical sights
- **TWO INTERCHANGEABLE LENGTH OF PULL SPACERS** allow you to fine-tune length of pull for a perfect stock fit
- **22" FULLY-RIFLED BARREL** is designed to provide optimum accuracy with modern sabots and slugs
- **3" CHAMBER** gives you the ability to reach out for challenging shots
- **BLACK CHROME PROTECTION** on the bolt and other components lasts longer than traditional bluing
- **TRUGLO® FIBER-OPTIC FRONT SIGHT AND ADJUSTABLE REAR SIGHT** offer a fast, natural sight picture
- **ALLOY RECEIVER** is drilled and tapped for scope bases
- **3-SHOT ADAPTOR WITH SPEED-PLUG SYSTEM** is easily removed without tools
- **ROTARY BOLT** with four massive lugs provides strength, support and solid lockup
- **DROP-OUT TRIGGER GROUP** allows for easy cleaning
- **CROSSBOLT SAFETY** is easily operated, even with gloves
- **INFLEX TECHNOLOGY RECOIL PAD** directs "felt recoil" down and away from your cheek

# PRO-GRADE.

## HIGHER-TECHNOLOGY PUMPS.



	ITEM NUMBER	GAUGE	BARREL LENGTH	CHAMBER	MAGAZINE CAPACITY	CHOKE TUBES INCLUDED	OVERALL LENGTH	LENGTH OF PULL	DROP AT COMB	DROP AT HEEL	NOMINAL WT. (LBS.)	SUGGESTED RETAIL
<b>SXP SHADOW DEFENDER</b>												
<b>NEW</b>	512327395	12	18"	3"	5*	CYL	38 1/2"	13 3/4"	1 3/8"	1 5/8"	6 1/4	\$449.99
<b>NEW</b>	512327695	20	18"	3"	5*	CYL	38 1/2"	13 3/4"	1 3/8"	1 5/8"	6	469.99
<b>SXP SHADOW MARINE DEFENDER</b>												
<b>NEW</b>	512328395	12	18"	3"	5*	CYL	38 1/2"	13 3/4"	1 3/8"	1 5/8"	6 1/4	\$499.99
<b>NEW</b>	512328695	20	18"	3"	5*	CYL	38 1/2"	13 3/4"	1 3/8"	1 5/8"	6 1/4	519.99

\*TOTAL AMMUNITION CAPACITY INCLUDES ONE ADDITIONAL SHELL IN THE CHAMBER



The receivers on both Winchester Super X® Pump Shadow Defender™ shotgun models are drilled and tapped for Winchester scope bases and rings, allowing you to easily attach an optional scope or electronic sight to fully utilize the incredible accuracy of today's shotgun slug ammo. See the full line of bases and rings on page 75.



**NEW**  
**SHADOW DEFENDER™**

- **SYNTHETIC PISTOL GRIP STOCK WITH TEXTURED GRIPPING SURFACES** give your hands a sure, non-slip grip and the non-glare matte black finish won't give you away
- **TWO INTERCHANGEABLE COMB PIECES** allow you to fine-tune drop at comb for use with iron, electronic or optical sights
- **TWO INTERCHANGEABLE LENGTH OF PULL SPACERS** allow you to fine-tune length of pull for a perfect stock fit
- **TACTICAL RIBBED FOREARM** for better control when you need it most
- **HARD CHROME-PLATED CHAMBER AND BORE** make these surfaces highly resistant to wear and corrosion
- **INVECTOR-PLUS CYLINDER CHOKE TUBE** handles both slugs and buckshot

- **3" CHAMBER** gives you the ability to reach out for challenging shots
- **BLACK CHROME PROTECTION** on the bolt and other components lasts longer than traditional bluing
- **TRADITIONAL BRASS BEAD FRONT SIGHT** plus a removable TRUGLO® fiber-optic sight offer a fast, natural sight picture
- **ALLOY RECEIVER** is drilled and tapped for scope bases
- **ROTARY BOLT** with four massive lugs provides strength, support and solid lockup
- **CROSSBOLT SAFETY** is easily operated, even with gloves
- **INFLEX TECHNOLOGY RECOIL PAD** directs "felt recoil" down and away from your cheek



**NEW**  
**SHADOW MARINE DEFENDER™**

- **MATTE HARD CHROME PLATING** on the barrel, magazine tube and slide arms for added resistance to wear and the elements
- **SYNTHETIC PISTOL GRIP STOCK WITH TEXTURED GRIPPING SURFACES** give your hands a sure, non-slip grip and the non-glare matte black finish won't give you away
- **TWO INTERCHANGEABLE COMB PIECES** allow you to fine-tune drop at comb for use with iron, electronic or optical sights
- **TWO INTERCHANGEABLE LENGTH OF PULL SPACERS** allow you to fine-tune length of pull for a perfect stock fit
- **TACTICAL RIBBED FOREARM** for better control when you need it most
- **HARD CHROME-PLATED CHAMBER AND BORE** make these surfaces highly resistant to wear and corrosion

- **INVECTOR-PLUS CYLINDER CHOKE TUBE** handles both slugs and buckshot
- **3" CHAMBER** gives you the ability to reach out for challenging shots
- **BLACK CHROME PROTECTION** on the bolt and other components lasts longer than traditional bluing
- **TRADITIONAL BRASS BEAD FRONT SIGHT** plus a removable TRUGLO® fiber-optic sight offer a fast, natural sight picture
- **ALLOY RECEIVER** is drilled and tapped for scope bases
- **ROTARY BOLT** with four massive lugs provides strength, support and solid lockup
- **CROSSBOLT SAFETY** is easily operated, even with gloves
- **INFLEX TECHNOLOGY RECOIL PAD** directs "felt recoil" down and away from your cheek



Two user-interchangeable combs and height adjust spacers let you tune comb height on your SXP® Shadow Defender™ and Shadow Marine Defender for perfect eye-to-sight alignment with your choice of sighting systems.



# CHA-CHUNK.

THE SOUND OF SOLID DEFENSE.



SXP





The receivers on both the Winchester Super X® Pump Defender and Marine Defender shotgun models are drilled and tapped for Winchester scope bases and rings. See the full line of bases and rings on page 75.



## DEFENDER™

- **SYNTHETIC STOCK WITH TEXTURED GRIPPING SURFACES** give your hands a sure, non-slip grip and the non-glare matte black finish won't give you away
- **TACTICAL RIBBED FOREARM** for better control when you need it most
- **HARD CHROME-PLATED CHAMBER AND BORE** make these surfaces highly resistant to wear and corrosion
- **FIXED CYLINDER CHOKE** barrel handles both slugs and buckshot
- **ALLOY RECEIVER** is drilled and tapped for scope bases

- **TRADITIONAL BRASS BEAD FRONT SIGHT** offers a fast, natural sight picture
- **ROTARY BOLT** with four massive lugs provides strength and solid lockup
- **DROP-OUT TRIGGER GROUP** allows for easy cleaning
- **CROSSBOLT SAFETY** is easily operated, even with gloves
- **BLACK CHROME PROTECTION** on the bolt and other components lasts longer than traditional bluing
- **INFLEX TECHNOLOGY RECOIL PAD** directs "felt recoil" down and away from your cheek to reduce flinch and fatigue



CYL

## MARINE DEFENDER™

- **SYNTHETIC STOCK WITH TEXTURED GRIPPING SURFACES** give your hands a sure, non-slip grip and the non-glare matte black finish won't give you away
- **TACTICAL RIBBED FOREARM** for better control when you need it most
- **HARD CHROME-PLATED CHAMBER AND BORE** make these surfaces highly resistant to wear and corrosion
- **MATTE HARD CHROME PLATING** on barrel, magazine tube, slide arms and other components for the ultimate protection against wear and the elements
- **ALLOY RECEIVER** is drilled and tapped for scope bases

- **TRADITIONAL BRASS BEAD FRONT SIGHT** plus a removable TRUGLO® fiber-optic sight offer a fast, natural sight picture
- **INVECTOR-PLUS CHOKE TUBE SYSTEM** with cylinder choke installed, works with slugs or buckshot
- **ROTARY BOLT** with four massive lugs provides strength and solid lockup
- **DROP-OUT TRIGGER GROUP** allows for easy cleaning
- **CROSSBOLT SAFETY** is easily operated, even with gloves
- **INFLEX TECHNOLOGY RECOIL PAD** directs "felt recoil" down and away from your cheek to reduce flinch and fatigue

ITEM NUMBER	GAUGE	BARREL LENGTH	CHAMBER	MAGAZINE CAPACITY	CHOKE TUBES INCLUDED	OVERALL LENGTH	LENGTH OF PULL	DROP AT COMB	DROP AT HEEL	NOMINAL WT. (LBS.)	SUGGESTED RETAIL
<b>SXP DEFENDER</b>											
512252395	12	18"	3"	5*	N/A	38 1/2"	13 3/4"	1 3/8"	1 5/8"	6 1/4	\$349.99
512252695	20	18"	3"	5*	N/A	38 1/2"	13 3/4"	1 3/8"	1 5/8"	6	379.99
<b>SXP MARINE DEFENDER</b>											
512268395	12	18"	3"	5*	CYL	38 1/2"	13 3/4"	1 3/8"	1 5/8"	6 1/4	\$399.99
512268695	20	18"	3"	5*	CYL	38 1/2"	13 3/4"	1 3/8"	1 5/8"	6 1/4	429.99

\*TOTAL AMMUNITION CAPACITY INCLUDES ONE ADDITIONAL SHELL IN THE CHAMBER

# GOBBLE 'EM UP. THREE TOP TOM TAKERS.



BACK-BORED  
TECHNOLOGY

TRUGLO

TURKEY HUNTER

SXP



Two user-interchangeable combs and height adjust spacers let you tune comb height on your SXP® Long Beard® for perfect eye-to-sight alignment with your choice of sighting systems.

## LONG BEARD® CHOKE TUBE

Aggressively avid turkey hunters will go to great lengths to tag that trophy tom. The Winchester Super X® Pump Long Beard® model features an extended Extra-Full Turkey tube with a fluted body, knurled friction ring and camo front band. It's designed to extract every bit of potential from Winchester's® Long Beard® XR® turkey ammunition.





**BACK-BORED TECHNOLOGY**

**TRUGLO**

**NEW TURKEY**

- **SYNTHETIC STOCK WITH TEXTURED GRIPPING SURFACES** give your hands a sure, non-slip grip and is available in your choice of either Mossy Oak® Break-Up Country® camo or a non-glare matte black finish that won't spook wary birds
- **BACK-BORED TECHNOLOGY** provides optimum shot patterns that are dense and even
- **A 3" CHAMBER IN 20 GAUGE, OR A 3 1/2" CHAMBER IN 12 GAUGE** gives you the power to reach out for those long-range turkeys
- **INVECTOR-PLUS EXTRA-FULL TURKEY CHOKE TUBE** for a tight, dense pattern
- **HARD CHROME-PLATED CHAMBER AND BORE** make these surfaces highly resistant to wear and corrosion

- **ALLOY RECEIVER** is drilled and tapped for scope bases
- **TRUGLO® FIBER-OPTIC ADJUSTABLE SIGHTS** offer a fast, natural sight picture
- **ROTARY BOLT** with four massive lugs provides strength and solid lockup
- **DROP-OUT TRIGGER GROUP** allows for easy cleaning
- **CROSSBOLT SAFETY** is easily operated, even with gloves
- **BLACK CHROME PROTECTION** on the bolt and other components lasts longer than traditional bluing
- **INFLEX TECHNOLOGY RECOIL PAD** directs "felt recoil" down and away from your cheek to reduce flinch and fatigue



**BACK-BORED TECHNOLOGY**

**TRUGLO**

LB

**LONG BEARD®**

- **SYNTHETIC PISTOL GRIP STOCK WITH TEXTURED GRIPPING SURFACES** give your hands a sure, non-slip grip and the Mossy Oak® Break-Up Country® camo finish won't spook wary birds
- **TWO INTERCHANGEABLE COMB PIECES** allow you to fine-tune drop at comb for use with iron, electronic or optical sights
- **TWO INTERCHANGEABLE LENGTH OF PULL SPACERS** allow you to fine-tune length of pull for a perfect-stock fit
- **BACK-BORED TECHNOLOGY** provides optimum shot patterns that are dense and even
- **CHOICE OF 3" OR 3 1/2" CHAMBER** gives you the power to reach out for those long-range turkeys
- **INVECTOR-PLUS EXTRA-FULL LONG BEARD® TURKEY CHOKE TUBE** for a tight, dense pattern, especially with Winchester® Long Beard® XR® ammunition

- **HARD CHROME-PLATED CHAMBER AND BORE** make these surfaces highly resistant to wear and corrosion
- **ALLOY RECEIVER** is drilled and tapped for scope bases
- **TRUGLO® FIBER-OPTIC ADJUSTABLE SIGHTS** offer a fast, natural sight picture
- **ROTARY BOLT** with four massive lugs provides strength and solid lockup
- **DROP-OUT TRIGGER GROUP** allows for easy cleaning
- **CROSSBOLT SAFETY** is easily operated, even with gloves
- **BLACK CHROME PROTECTION** on the bolt and other components lasts longer than traditional bluing
- **INFLEX TECHNOLOGY RECOIL PAD** directs "felt recoil" down and away from your cheek to reduce flinch and fatigue

	ITEM NUMBER	GAUGE	BARREL LENGTH	CHAMBER	MAGAZINE CAPACITY	CHOKE TUBES INCLUDED	OVERALL LENGTH**	LENGTH OF PULL	DROP AT COMB	DROP AT HEEL	NOMINAL WT. (LBS.)	SUGGESTED RETAIL
<b>SXP TURKEY</b>												
NEW	512341290	12	24"	3 1/2"	4*	T	45"	13 3/4"	1 5/8"	2"	6 5/8	\$439.99
NEW	512341690	20	24"	3"	5*	T	45"	13 3/4"	1 5/8"	2"	6 1/4	439.99
<b>SXP TURKEY HUNTER</b>												
	512307290	12	24"	3 1/2"	4*	T	45"	13 3/4"	1 5/8"	2"	6 5/8	\$519.99
	512307690	20	24"	3"	5*	T	45"	13 3/4"	1 5/8"	2"	6 1/4	519.99
<b>SXP LONG BEARD</b>												
	512320290	12	24"	3 1/2"	4*	Long Beard	43"	13 3/4"	1 3/4"	2"	7 1/4	\$559.99
	512320390	12	24"	3"	4*	Long Beard	42 1/2"	13 3/4"	1 3/4"	2"	7 1/4	529.99

\*TOTAL AMMUNITION CAPACITY INCLUDES ONE ADDITIONAL SHELL IN THE CHAMBER

\*\*OVERALL LENGTH DOES NOT INCLUDE CHOKE TUBE

# MODEL 101<sup>®</sup>

## THE DEFINITION OF ELEGANCE.

IF YOU'VE ALWAYS WANTED TO EXPERIENCE THE QUALITY AND PERFORMANCE OF A FINE BELGIAN-MADE OVER AND UNDER, HERE'S THE PERFECT STACKBARREL FOR YOU. THE LEGENDARY MODEL 101<sup>®</sup> IS BUILT ALONG THE CLASSIC LINES OF THE ORIGINAL, USING THE LATEST IN MANUFACTURING PROCESSES AND MATERIALS TO CREATE AN OVER AND UNDER DESIGNED TO GIVE MANY YEARS OF SATISFACTION.



Today's Model 101<sup>®</sup> features the same **FAMILIAR DIMENSIONS** set long ago by the original. The familiar drop at comb and narrow, comfortable grip ensure time-tested comfort and performance.



The Model 101<sup>®</sup> has the drop on the original with the advantage of a **LOW-PROFILE RECEIVER**. This means that recoil occurs in-line, directly back for faster follow-up shots with less muzzle jump. Also, your forward hand is placed closer to the bore centerline, bringing your hands, face and sighting plane into a more natural alignment for more intuitive and accurate shooting.



An **ADJUSTABLE COMB** stock allows you to modify individual height and cast on/off for a custom fit in just seconds. (Hex wrench is included.)

Every Model 101<sup>®</sup> shotgun has **FINELY CUT CHECKERING** to improve grip and add artistic elegance to the well-figured walnut stock and forearm.



Getting pounded by recoil is now a thing of the past with the patented **PACHMAYR<sup>®</sup> DECELERATOR<sup>®</sup> RECOIL PAD** with snag-free heel. Found on all Model 101<sup>®</sup> shotguns, it reduces "felt recoil" to very manageable levels, even when shooting heavy magnum loads.

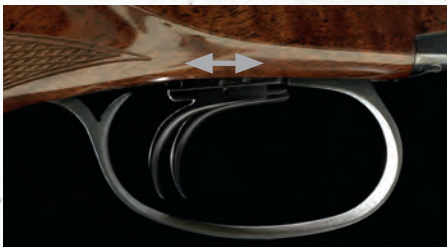

An **ADJUSTABLE TRIGGER SHOE** lets you fine tune its fore and aft position to your precise length of pull for more comfortable shooting on Pigeon and Sporting models. (A steel hex wrench is included.)



Sporting and Field models have a fitted **STEEL GRIP CAP** to add a touch of graceful elegance.

MODEL 101<sup>®</sup>

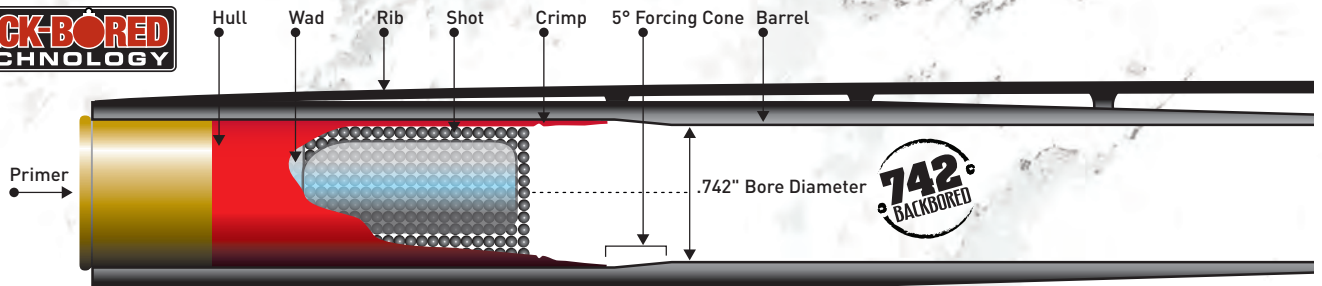

**BACK-BORED TECHNOLOGY** is based on extensive research and testing to find the secret to tighter, more consistent patterns. Instead of the traditional bore size of .729", this research shows the ideal 12 gauge interior diameter is .742". If the bore is any larger the gases will blow by the shot cup and reduce pellet velocity. If the bore is too tight the pellets are deformed as they pass through the forcing cone, causing poor ballistic performance.



**CHROME-PLATED CHAMBERS AND BORES** are found in all Winchester Model 101® shotguns. This critical plating provides protection from thousands of heavy, high density, abrasive loads. This extra feature virtually eliminates wear and tear caused by thousands of shells.



From the field to the range, the **INVECTOR-PLUS CHOKE TUBE SYSTEM** is the world's most consistent. All Model 101® shotguns come with either extended Signature or flush-mounted Invector-Plus tubes, depending on the model. Additional tubes are available at your local firearms dealer.



**TOUGH STEEL HINGE** areas bear tension from recoil with each shot, so the Model 101® shotgun is built with surfaces that are 49% larger than many competitors. The surfaces are machined simultaneously with the hinge, ensuring perfect alignment.

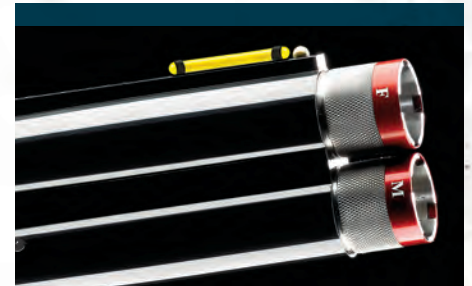

## TRUGLO

Model 101 Pigeon Trap and Sporting models feature **TRUGLO® FIBER-OPTIC FRONT SIGHTS** for faster target acquisition.



The Model 101® shotgun's **LOCKING LUGS** have 30% more contact surface than the competition for an action that's the strongest in the industry and built to last.



# DOUBLE FUN. GO PLAY IN THE CLAYS.



MODEL 101® PIGEON TRAP  
ADJUSTABLE COMB

MODEL 101



T-WRENCH, LF, IM, M, IC, SK

**SPORTING**

- **HIGH GLOSS GRADE II/III WALNUT STOCK WITH 20 LINES-PER-INCH CUT CHECKERING** looks elegant and improves grip
- **TRADITIONAL MODEL 101® SHOTGUN DIMENSIONS** give you a performance advantage plus classic styling
- **LOW-PROFILE RECEIVER** gives you faster target acquisition, a more controlled swing and less "felt recoil"
- **TRUGLO® TRU-BEAD® INTERCHANGEABLE FIBER-OPTIC FRONT SIGHT** offers a fast, natural sight picture
- **BACK-BORED TECHNOLOGY** provides optimum shot patterns that are dense and even
- **STEEL GRIP CAP** adds a touch of classic elegance

- **EXTENDED SIGNATURE INVECTOR-PLUS CHOKE TUBES** offer predictable patterns to match your situation
- **ADJUSTABLE TRIGGER SHOE** for perfect length of pull
- **HARD CHROME-PLATED CHAMBERS AND BORES** make these surfaces highly resistant to wear and corrosion
- **49% MORE HINGE SURFACE AREA** than our competitors, giving you greater strength for long-term wear
- **30% MORE LOCKING LUG CONTACT AREA** keeps the action tighter and minimizes wear
- **PACHMAYR® DECELERATOR® RECOIL PAD** absorbs "felt recoil" to reduce flinch and fatigue



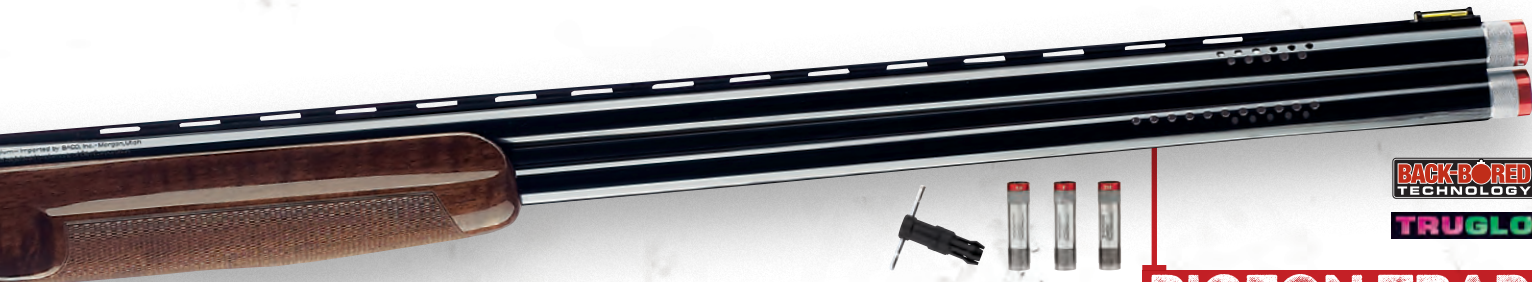

T-WRENCH, XF, F, IM

## PIGEON TRAP

- **HIGH GLOSS GRADE II/III WALNUT STOCK WITH 20 LINES-PER-INCH CUT CHECKERING** looks elegant and improves grip
- **ADJUSTABLE COMB OPTION** lets you custom fit the stock to your shooting style
- **LOW-PROFILE NICKEL-PLATED RECEIVER WITH CLASSIC PIGEON ENGRAVING** gives you faster target acquisition, a more controlled swing and less "felt recoil"
- **TRUGLO® TRU-BEAD® INTERCHANGEABLE FIBER-OPTIC FRONT SIGHT** offers a true, precise sight picture
- **TRADITIONAL MODEL 101® SHOTGUN DIMENSIONS** give you a performance advantage plus classic styling
- **EXTENDED SIGNATURE INVECTOR-PLUS CHOKE TUBES** offer predictable patterns to match your situation
- **BACK-BORED BARRELS** provide optimum shot patterns that are dense and even
- **PORTED BARRELS** reduce muzzle jump and help tame felt recoil
- **ADJUSTABLE TRIGGER** for perfect length of pull
- **HARD CHROME-PLATED CHAMBERS AND BORES** make these surfaces highly resistant to wear and corrosion
- **WHITE LINE SPACER PACHMAYR® DECELERATOR® RECOIL PAD** provides optimal protection against "felt recoil"



EVERY MODEL 101® SPORTING AND TRAP SHOTGUN COMES WITH A DURABLE, FITTED ABS HARD CASE IMPRINTED WITH THE WINCHESTER REPEATING ARMS® LOGO.

ITEM NUMBER	GAUGE	BARREL LENGTH	CHAMBER	CHOKE TUBES INCLUDED	OVERALL LENGTH**	LENGTH OF PULL	DROP AT COMB	DROP AT HEEL	NOMINAL WT. (LBS.)	SUGGESTED RETAIL
<b>MODEL 101 PIGEON TRAP</b>										
513057493	12	30"	2 3/4"	XF, F, IM	47 5/8"	14 5/8"	1 1/2"	2 3/8"	7 1/2	\$2,519.99
513057494	12	32"	2 3/4"	XF, F, IM	49 5/8"	14 5/8"	1 1/2"	2 3/8"	7 5/8	2,519.99
<b>MODEL 101 PIGEON TRAP (ADJUSTABLE COMB)</b>										
513059493	12	30"	2 3/4"	XF, F, IM	47 5/8"	14 5/8"	1 1/2"*	2 3/8"*	7 1/2	\$2,679.99
513059494	12	32"	2 3/4"	XF, F, IM	49 5/8"	14 5/8"	1 1/2"*	2 3/8"*	7 5/8	2,679.99
<b>MODEL 101 SPORTING</b>										
513054492	12	28"	2 3/4"	LF, IM, M, IC, SK	45 5/8"	14 5/8"	1 3/8"	2 3/8"	7 1/8	\$2,379.99
513054493	12	30"	2 3/4"	LF, IM, M, IC, SK	47 5/8"	14 5/8"	1 3/8"	2 3/8"	7 1/4	2,379.99
513054494	12	32"	2 3/4"	LF, IM, M, IC, SK	49 5/8"	14 5/8"	1 3/8"	2 3/8"	7 3/8	2,379.99

\*ADJUSTABLE COMB STOCK DIMENSIONS ARE MEASURED WITH COMB IN THE LOWEST POSITION. \*\*DOES NOT INCLUDE ADDED LENGTH OF CHOKE TUBES.

# SWING TIME.

DUSTING FEATHERS ALL SEASON LONG.



MODEL 101<sup>®</sup>

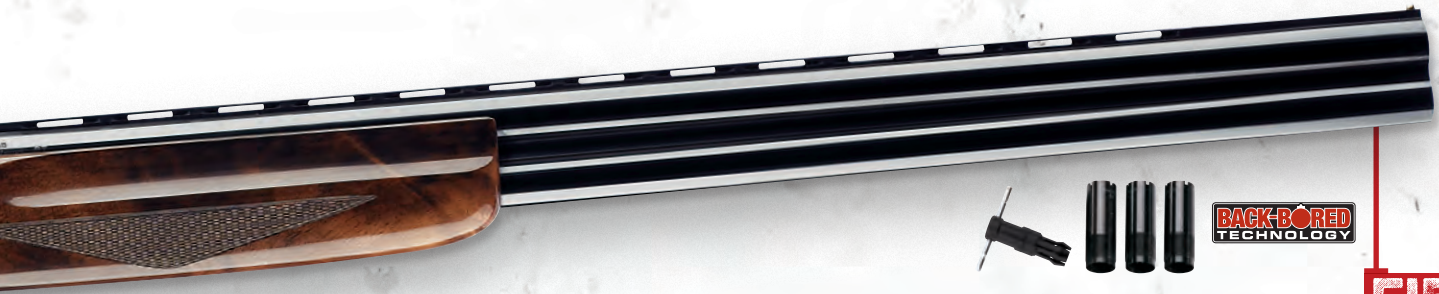

T-WRENCH, F, M, IC

**FIELD**

- **HIGH GLOSS GRADE II/III WALNUT STOCK WITH 20 LINES-PER-INCH CUT CHECKERING** looks elegant and improves grip
- **LOW-PROFILE RECEIVER** gives you faster target acquisition, a more controlled swing and less "felt recoil"
- **STEEL GRIP CAP** adds a classic touch
- **BACK-BORED BARRELS** provide optimum shot patterns that are dense and even
- **HARD CHROME-PLATED CHAMBERS AND BORES** make these surfaces highly resistant to wear and corrosion
- **INVECTOR-PLUS CHOKE TUBES** offer predictable patterns to match your situation
- **49% MORE HINGE SURFACE AREA** than our competitors, giving you greater strength for long-term wear
- **30% MORE LOCKING LUG CONTACT AREA** keeps the action tighter and minimizes wear
- **WHITE LINE SPACER PACHMAYR® DECELERATOR® RECOIL PAD** provides optimal protection against "felt recoil"

ITEM NUMBER	GAUGE	BARREL LENGTH	CHAMBER	CHOKE TUBES INCLUDED	OVERALL LENGTH	LENGTH OF PULL	DROP AT COMB	DROP AT HEEL	NOMINAL WT. (LBS.)	SUGGESTED RETAIL
<b>MODEL 101 FIELD</b>										
513046371	12	26"	3"	F, M, IC	43 1/4"	14 1/4"	1 3/8"	2 3/8"	6 3/4	\$1,899.99
513046361	12	28"	3"	F, M, IC	45 1/4"	14 1/4"	1 3/8"	2 3/8"	7	1,899.99

# HISTORY.

## GRAB HOLD WITH BOTH HANDS.

HERE'S THE CHANCE TO FILL YOUR HANDS WITH WESTERN HISTORY. NO OTHER FIREARM BRAND BRINGS TO LIFE THE ACTION, THE ROMANCE AND THE LEGACY OF THE WILD WEST LIKE WINCHESTER®. IT'S HIGH TIME TO SADDLE UP AND HEAD OUT WEST WITH THESE LEGENDARY LONG GUNS FROM WINCHESTER REPEATING ARMS.

# HISTORICAL

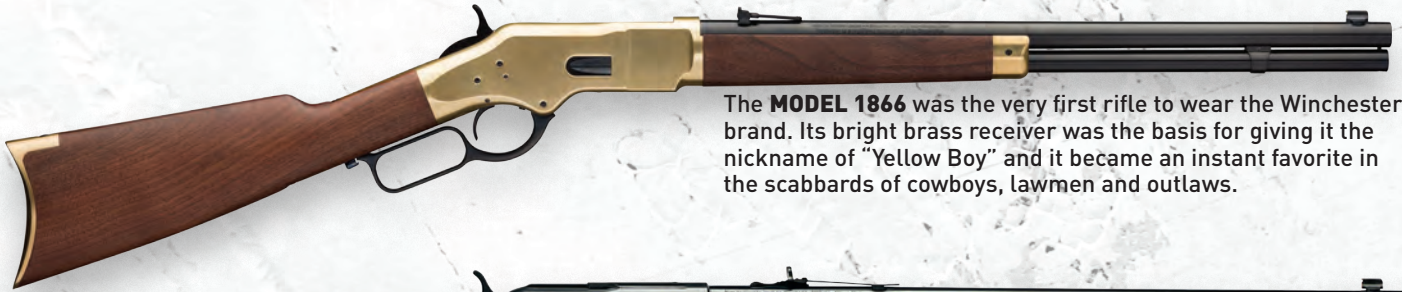

The **MODEL 1866** was the very first rifle to wear the Winchester® brand. Its bright brass receiver was the basis for giving it the nickname of "Yellow Boy" and it became an instant favorite in the scabbards of cowboys, lawmen and outlaws.

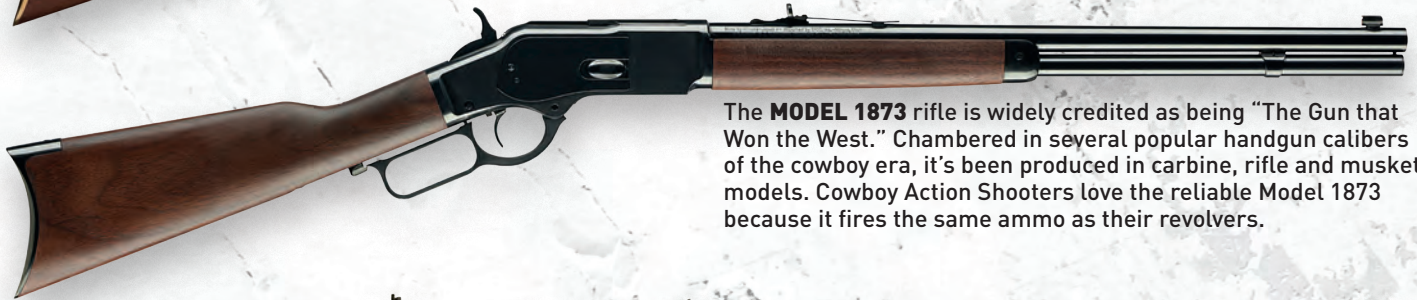

The **MODEL 1873** rifle is widely credited as being "The Gun that Won the West." Chambered in several popular handgun calibers of the cowboy era, it's been produced in carbine, rifle and musket models. Cowboy Action Shooters love the reliable Model 1873 because it fires the same ammo as their revolvers.



The **MODEL 1885 HIGH WALL** rifle was John M. Browning's first commercial firearm design for Winchester®. This stout falling-block action is so versatile it's been chambered in pistol cartridges up to the powerful belted magnums. It's remained the gold standard of single shot rifles for more than 125 years.

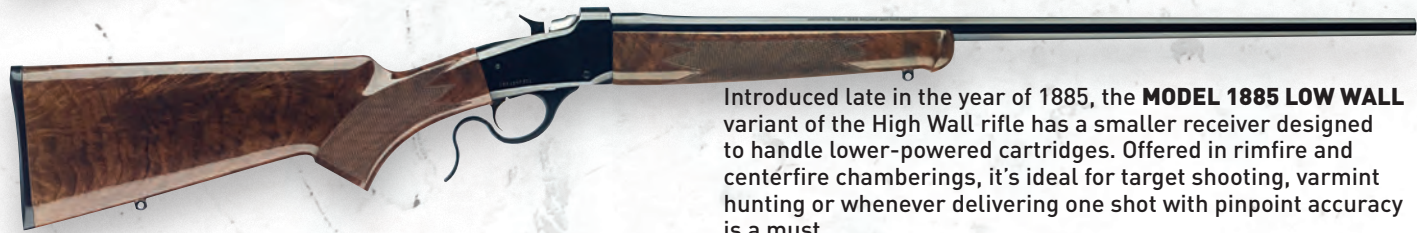

Introduced late in the year of 1885, the **MODEL 1885 LOW WALL** variant of the High Wall rifle has a smaller receiver designed to handle lower-powered cartridges. Offered in rimfire and centerfire chamberings, it's ideal for target shooting, varmint hunting or whenever delivering one shot with pinpoint accuracy is a must.



The **MODEL 1886** rifle was John M. Browning's second design for Winchester®. Robust and accurate, it's capable of handling the long, powerful black powder "buffalo" cartridges popular on the Western Plains. The 45-70 Government is the all-time classic chambering for this legendary rifle design.

Please note that these firearms are representative of the legendary guns that make up the Winchester Repeating Arms Historic product line. They are made in very limited quantities and will rotate in and out of production on an ongoing basis. Thus not every gun shown here will be produced every year. Available historic products for 2017 are shown on pages 44 to 57.

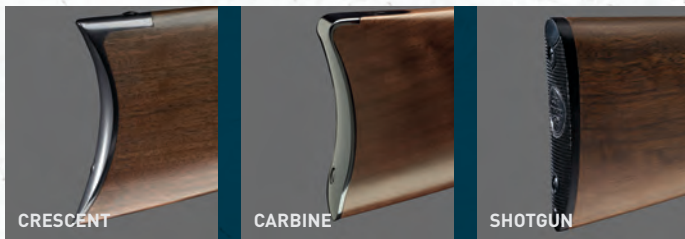

CRESCENT

CARBINE

SHOTGUN

Winchester® historic rifles have long been offered with **TRADITIONAL BUTTPLATE DESIGNS** including a **CRESCENT METAL PLATE**, a **METAL CARBINE STRAP** and several variations of the classic flat **SHOTGUN BUTTPLATE**.



RIFLE FOREARM CAP

CARBINE BAND

Classic Winchester® firearms are often fitted with a **RIFLE FOREARM CAP** or a **CARBINE BAND** to add that authentic touch every cowboy wants.



STRAIGHT

CURVED PISTOL

The **TRADITIONAL STRAIGHT GRIP** and **CURVED PISTOL GRIP** are two hallmarks of a genuine Winchester® rifle or carbine.

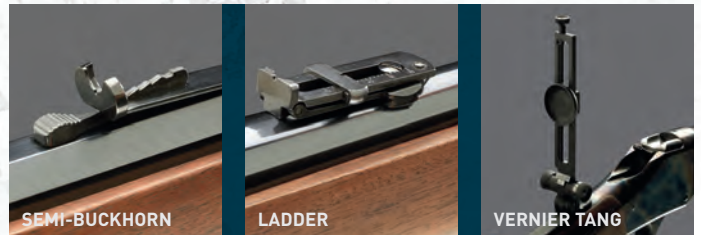

SEMI-BUCKHORN

LADDER

VERNIER TANG

Over the decades Winchester® rear sight designs have included the **SEMI-BUCKHORN**, the **LADDER SIGHT** and the **VERNIER TANG** or **PEEP TANG SIGHT**.

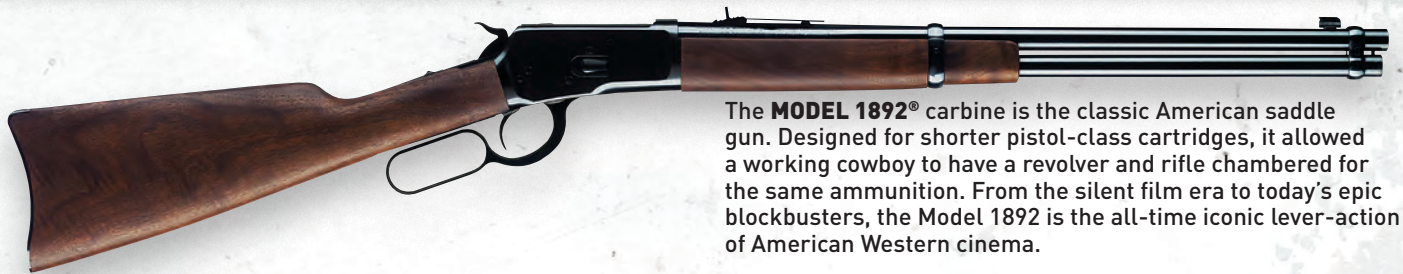

The **MODEL 1892®** carbine is the classic American saddle gun. Designed for shorter pistol-class cartridges, it allowed a working cowboy to have a revolver and rifle chambered for the same ammunition. From the silent film era to today's epic blockbusters, the Model 1892 is the all-time iconic lever-action of American Western cinema.

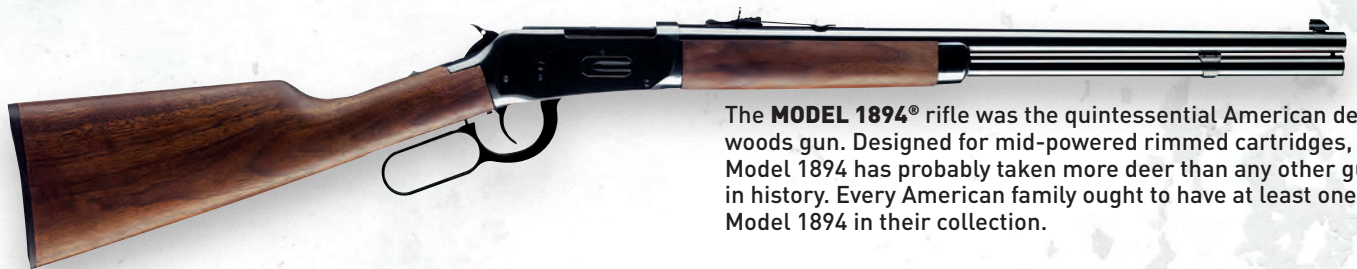

The **MODEL 1894®** rifle was the quintessential American deep woods gun. Designed for mid-powered rimmed cartridges, the Model 1894 has probably taken more deer than any other gun in history. Every American family ought to have at least one Model 1894 in their collection.



The **MODEL 1895™** rifle was designed with an internal box magazine, allowing the use of pointed bullets and the then-new bottleneck cartridges loaded with smokeless powder. Theodore Roosevelt called it his "Medicine Gun" and he used it with great success on his 1909 African safari.



The **MODEL 71** rifle is a modified version of the Model 1886 introduced by Winchester® in 1935. It's chambered for the robust 348 Winchester® cartridge. Designed for taking deer, black bear and even moose, the Model 71 is also perfect for taking a trophy boar on your next wild hog hunt.

# **YELLOW BOY.** **THE LEGENDARY WINCHESTER®** **RIFLE THAT STARTED IT ALL.**





**NEW**  
**SHORT RIFLE**

- **GRADE I AMERICAN BLACK WALNUT STRAIGHT GRIP STOCK** with a satin oil finish that's velvet smooth to the touch
- **CLASSIC RIFLE-STYLE FOREARM** with polished brass forearm cap for the timeless look and feel of the original Model 1866
- **FULL BRIGHT POLISH** gives a deep, traditional glow to the brass receiver, crescent buttplate and forearm cap
- **CRESCENT BRASS BUTTPLATE** slips right into your shoulder for a more solid hold from any shooting position
- **FOLDING LADDER REAR SIGHT WITH MARBLE ARMS® GOLD BEAD FRONT SIGHT** get you on target quickly
- **OPEN TOP EJECTION PORT** for easier single cartridge loading and smoother, more reliable ejection of fired cases
- **FULL-LENGTH MAGAZINE TUBE** aids in offhand balance and provides plenty of ammo capacity for hunting, competition and casual plinking
- **BLUED STEEL LOADING GATE** gives smoother loading and adds a touch of contrast against the highly polished brass receiver
- **BLUED STEEL ACTION SCREWS** create an added touch of tasteful contrast against the surface of the polished brass receiver

# 1866

	ITEM NUMBER	CALIBER	MAGAZINE CAPACITY	BARREL LENGTH	OVERALL LENGTH	LENGTH OF PULL	DROP AT COMB	DROP AT HEEL	NOMINAL WT. (LBS)	RATE OF TWIST	SUGGESTED RETAIL
<b>MODEL 1866 SHORT RIFLE</b>											
<b>NEW</b>	534244140	44-40 Win	10	20"	39"	13"	1 3/4"	3"	7 1/4	26"	\$1,299.99
<b>NEW</b>	534244188	38 Spcl	11	20"	39"	13"	1 3/4"	3"	7 1/4	18 3/4"	1,299.99

# HARD RIDERS.

THREE RIFLES THAT  
WON THE WEST.

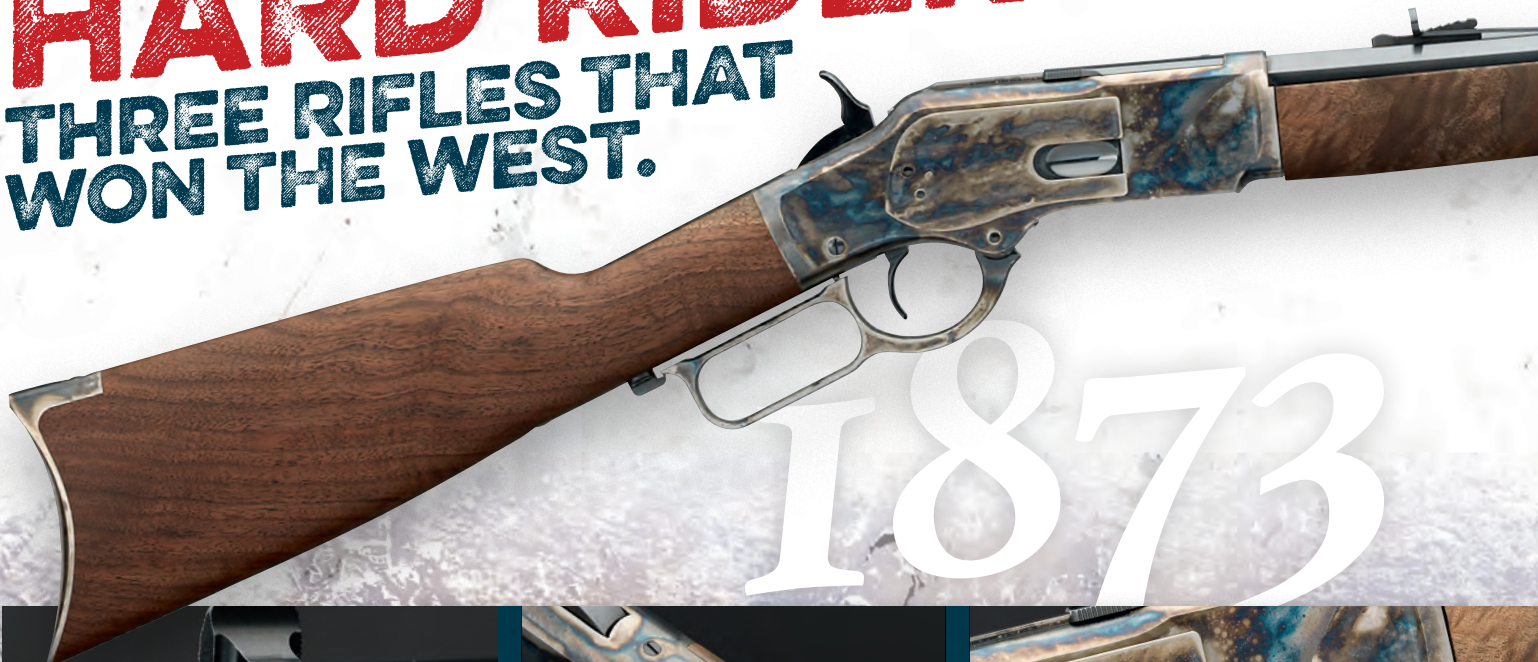

# 1873



FULL OCTAGON BARREL



DRILLED AND TAPPED TOP TANG

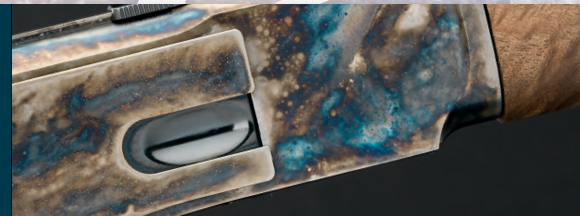

COLOR CASE HARDENING



ITEM NUMBER	CALIBER	MAGAZINE CAPACITY	BARREL LENGTH	OVERALL LENGTH	LENGTH OF PULL	DROP AT COMB	DROP AT HEEL	NOMINAL WT. (LBS)	RATE OF TWIST	SUGGESTED RETAIL
<b>MODEL 1873 SPORTER OCTAGON COLOR CASE HARDENED</b>										
534217137	357 Mag/38 Spl	13/14	24"	43"	13"	1 3/4"	3"	7 1/2	18 3/4"	\$1,739.99
<b>NEW</b> 534217141	45 Colt	10	20"	39"	13"	1 3/4"	3"	7 1/4	26"	1,739.99
534217140	44-40 Win	13	24"	43"	13"	1 3/4"	3"	7 1/2	26"	1,739.99



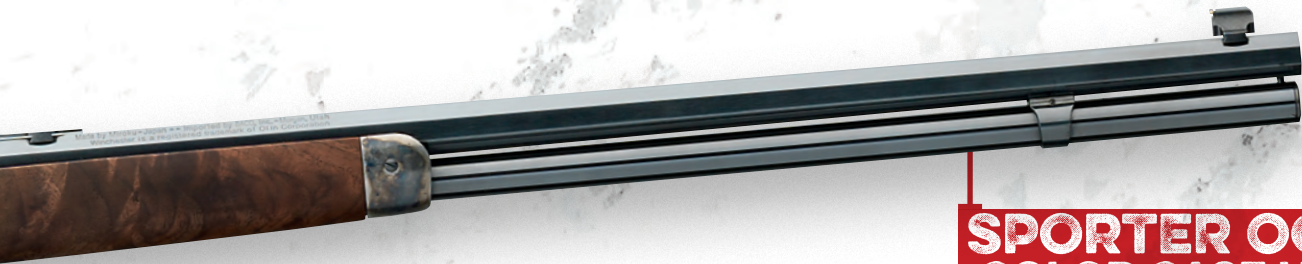

## SPORTER OCTAGON COLOR CASE HARDENED

- **GRADE II/III WALNUT STRAIGHT GRIP STOCK** with a satin oil finish that's velvet smooth to the touch
- **CLASSIC RIFLE-STYLE FOREARM** with forearm cap for the timeless look and feel of the original Model 1873
- **ELEGANT COLOR CASE HARDENING** on the robust steel receiver, lever, crescent buttplate and forearm cap protect against corrosion
- **CRESCENT BUTTPLATE** slips right into your shoulder for a more solid hold from any shooting position
- **SEMI-BUCKHORN REAR SIGHT WITH MARBLE ARMS® GOLD BEAD FRONT SIGHT** gets you on target quickly
- **STEEL LOADING GATE** for smoother loading
- **RECEIVER TOP TANG** is drilled and tapped for an optional tang-mounted rear sight that gives you a more precise sight picture and the timeless look and feel of shooting a long-barreled frontier rifle



## SPORTER OCTAGON Pistol GRIP COLOR CASE HARDENED

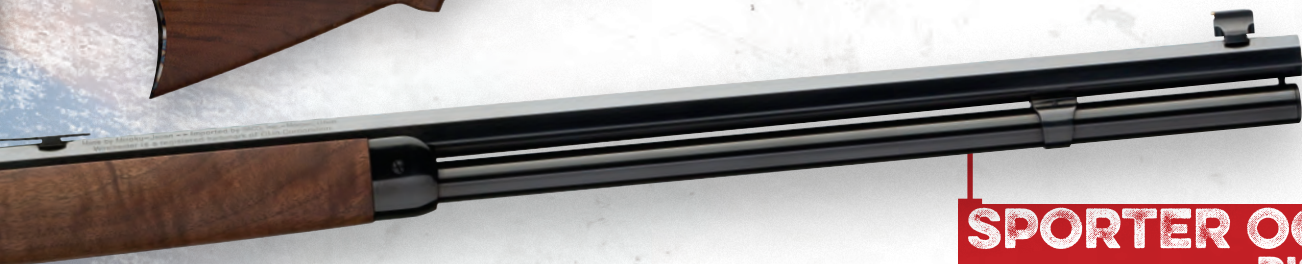

## SPORTER OCTAGON Pistol GRIP

- **GRADE II/III WALNUT PISTOL GRIP STOCK** with a satin oil finish that's velvet smooth to the touch
- **CLASSIC RIFLE-STYLE FOREARM** for the timeless look and feel of the original Model 1873
- **DEEPLY POLISHED BLUE OR COLOR CASE HARDENING** on the robust steel receiver, lever, crescent buttplate and forearm cap protect against corrosion
- **CRESCENT BUTTPLATE** slips right into your shoulder for a more solid hold from any shooting position
- **SEMI-BUCKHORN REAR SIGHT WITH MARBLE ARMS® GOLD BEAD FRONT SIGHT** gets you on target quickly
- **STEEL LOADING GATE** for smoother loading
- **RECEIVER TOP TANG** is drilled and tapped for an optional tang-mounted rear sight that gives you a more precise sight picture and the timeless look and feel of shooting a long-barreled frontier rifle

ITEM NUMBER	CALIBER	MAGAZINE CAPACITY	BARREL LENGTH	OVERALL LENGTH	LENGTH OF PULL	DROP AT COMB	DROP AT HEEL	NOMINAL WT. (LBS)	RATE OF TWIST	SUGGESTED RETAIL
<b>MODEL 1873 SPORTER OCTAGON PISTOL GRIP COLOR CASE HARDENED</b>										
534228137	357 Mag/38 Spl	13/14	24"	43"	13"	1 3/4"	3"	8	18 3/4"	\$1,739.99
534228141	45 Colt	13	24"	43"	13"	1 3/4"	3"	8	26"	1,739.99
534228140	44-40 Win	13	24"	43"	13"	1 3/4"	3"	8	26"	1,739.99
<b>MODEL 1873 SPORTER OCTAGON PISTOL GRIP</b>										
534229137	357 Mag/38 Spl	13/14	24"	43"	13"	1 3/4"	3"	8	18 3/4"	\$1,469.99
534229141	45 Colt	13	24"	43"	13"	1 3/4"	3"	8	26"	1,469.99
534229140	44-40 Win	13	24"	43"	13"	1 3/4"	3"	8	26"	1,469.99

# SHORT RIFLES.

A PAIR OF SHOOTING ACES.

1873





**TRADITIONAL DUST COVER**



**ULTRA-SMOOTH ACTION**



**BRASS CARTRIDGE LIFTER**



**SHORT RIFLE**

- **WALNUT STRAIGHT GRIP STOCK** with a satin oil finish that's velvet smooth to the touch
- **CLASSIC RIFLE-STYLE FOREARM** with blued steel cap for the timeless look and feel of the original Model 1873
- **BLUED STEEL CRESCENT BUTTPLATE** slips into your shoulder for a solid hold
- **SEMI-BUCKHORN REAR SIGHT WITH MARBLE ARMS® GOLD BEAD FRONT SIGHT** get you on target quickly

- **STEEL LOADING GATE** for smoother loading
- **BRASS CARTRIDGE LIFTER** for more reliable feeding, even during the heat of cowboy action competition
- **RECEIVER TOP TANG** is drilled and tapped for an optional tang-mounted rear sight for a more precise sight picture

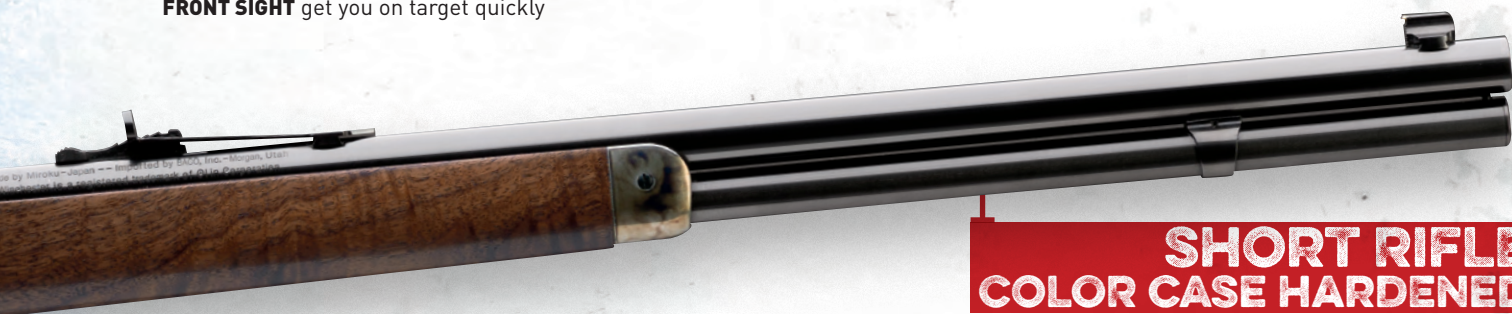

**SHORT RIFLE  
COLOR CASE HARDENED**

- **WALNUT STRAIGHT GRIP STOCK** with a satin oil finish that's velvet smooth to the touch
- **CLASSIC RIFLE-STYLE FOREARM** with color case hardened cap for the timeless look and feel of the original Model 1873
- **MAGNIFICENT COLOR CASE HARDENING** on the robust steel receiver
- **COLOR CASE HARDENED STEEL CRESCENT BUTTPLATE** slips into your shoulder for a solid hold

- **SEMI-BUCKHORN REAR SIGHT WITH MARBLE ARMS® GOLD BEAD FRONT SIGHT** get you on target quickly
- **STEEL LOADING GATE** for smoother loading
- **RECEIVER TOP TANG** is drilled and tapped for an optional tang-mounted rear sight for a more precise sight picture

ITEM NUMBER	CALIBER	MAGAZINE CAPACITY	BARREL LENGTH	OVERALL LENGTH	LENGTH OF PULL	DROP AT COMB	DROP AT HEEL	NOMINAL WT. (LBS)	RATE OF TWIST	SUGGESTED RETAIL
<b>MODEL 1873 SHORT RIFLE</b>										
534200137	357 Mag/38 Spl	10/11	20"	39"	13"	1 3/4"	3"	7 1/4	18 3/4"	\$1,299.99
534200140	44-40 Win	10	20"	39"	13"	1 3/4"	3"	7 1/4	26"	1,299.99
534200141	45 Colt	10	20"	39"	13"	1 3/4"	3"	7 1/4	26"	1,299.99
<b>MODEL 1873 SHORT RIFLE COLOR CASE HARDENED</b>										
534202137	357 Mag/38 Spl	10/11	20"	39"	13"	1 3/4"	3"	7 1/4	18 3/4"	\$1,579.99
534202140	44-40 Win	10	20"	39"	13"	1 3/4"	3"	7 1/4	26"	1,579.99
534202141	45 Colt	10	20"	39"	13"	1 3/4"	3"	7 1/4	26"	1,579.99

# JUST RIGHT.

## FOR BOTH SMALLBORE AND BIG BORE FANS.



# 1885



# 1886

### SHORT RIFLE

- **GRADE I SATIN FINISH WALNUT STOCK** for classic beauty
- **STRAIGHT GRIP** for genuine good looks and fast handling
- **STEEL CRESCENT BUTTPLATE** adds traditional look while protecting the buttstock
- **MARBLE ARMS® FRONT SIGHT** with brass bead for easier sighting
- **ADJUSTABLE REAR SIGHT** gets you on target with any ammo
- **STEEL LOADING GATE** for smoother loading
- **BARREL** is button-rifled with a recessed crown for ultimate accuracy
- **RECEIVER** is drilled and tapped for an optional receiver mounted peep sight for a more precise sight picture



NOTE: REAR SIGHT HAS BEEN REMOVED TO ALLOW THE SCOPE TO BE MOUNTED.

## HUNTER RIMFIRE

- **CHECKERED WALNUT PISTOL GRIP STOCK** with an oil finish that's velvet smooth to the touch
- **TIMELESS SCHNABEL STYLE FOREARM** with cut checkering sets the Hunter Rimfire apart from other rifles
- **PACHMAYR® RUBBER BUTTPAD** for non-slip shooting comfort
- **OCTAGON 24" BARREL** is button rifled for outstanding accuracy
- **SEMI-BUCKHORN REAR SIGHT WITH MARBLE ARMS® GOLD BEAD FRONT SIGHT** get you on target quickly
- **CURVED BLUED STEEL FINGER LEVER** is comfortable in the hand and smoothly activates the steel falling breechblock for loading and ejection
- **BLUED STEEL RECEIVER AND BARREL** are drilled and tapped for scope mounting



## DELUXE RIFLE

- **HIGH GRADE III/IV SATIN FINISH WALNUT STOCK** for deep grain beauty, with classic cut checkering for a sure grip
- **PISTOL GRIP** for good looks, improved grip and fast handling
- **STEEL CRESCENT BUTTPLATE** adds a traditional look while protecting the buttstock
- **COLOR CASE HARDENING** on the robust steel receiver, lever, crescent buttplate, grip cap, lower tang and forearm cap protect against corrosion
- **MARBLE ARMS® FRONT SIGHT** with brass bead for easier sighting
- **ADJUSTABLE REAR SIGHT** gets you on target with any ammo
- **STEEL LOADING GATE** for smoother loading
- **BARREL** is button-rifled with a recessed crown for ultimate accuracy
- **RECEIVER** is drilled and tapped for an optional receiver mounted peep sight for a more precise sight picture

ITEM NUMBER	CALIBER	MAGAZINE CAPACITY	BARREL LENGTH	OVERALL LENGTH	LENGTH OF PULL	DROP AT COMB	DROP AT HEEL	NOMINAL WT. (LBS)	RATE OF TWIST	SUGGESTED RETAIL
<b>MODEL 1885 LOW WALL HUNTER RIMFIRE</b>										
524100102	22 LR	N/A	24"	40"	13 1/2"	3/4"	1 1/4"	7 1/2	16"	\$1,469.99
524100104	22 WMR	N/A	24"	40"	13 1/2"	3/4"	1 1/4"	7 1/2	16"	1,469.99
524100170	17 HMR	N/A	24"	40"	13 1/2"	3/4"	1 1/4"	7 1/2	9"	1,469.99
524100186	17 WSM	N/A	24"	40"	13 1/2"	3/4"	1 1/4"	7 1/2	9"	1,469.99
<b>MODEL 1886 DELUXE RIFLE</b>										
534227142	45-70 Govt	8	24"	43"	13 1/4"	1 1/4"	2"	8 3/8	20"	\$1,739.99
<b>MODEL 1886 SHORT RIFLE</b>										
534175142	45-70 Govt	8	24"	43"	13 1/4"	1 1/4"	2"	8 3/8	20"	\$1,339.99

(SCOPE AND MOUNTS SHOWN NOT INCLUDED)

**GO GET 'EM.**  
**TIMELESS SADDLE GUNS.**



1892

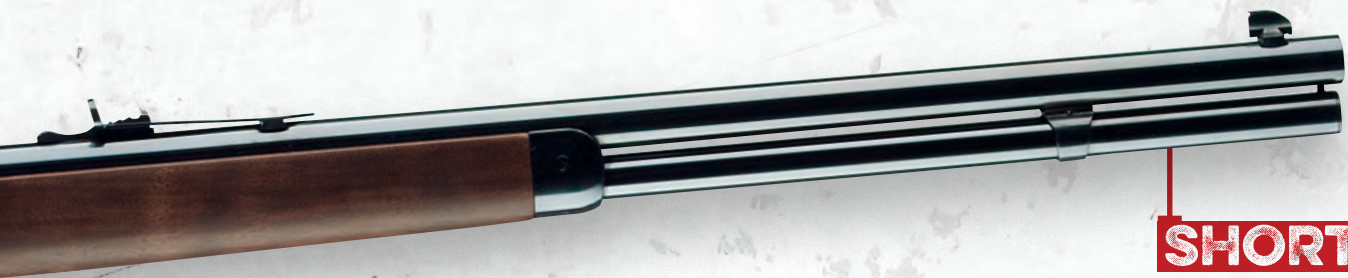

## SHORT RIFLE

- **WALNUT STRAIGHT GRIP STOCK** with a satin finish that's velvet smooth to the touch
- **CLASSIC RIFLE-STYLE FOREARM** with blued steel cap for the timeless look and feel of the original Model 1892® rifle
- **BLUED STEEL CRESCENT BUTTPLATE** slips into your shoulder for a solid hold

- **SEMI-BUCKHORN REAR SIGHT WITH MARBLE ARMS® GOLD BEAD FRONT SIGHT** get you on target quickly
- **STEEL LOADING GATE** for smoother loading
- **TOP TANG** is drilled and tapped for an optional receiver mounted peep sight for a more precise sight picture

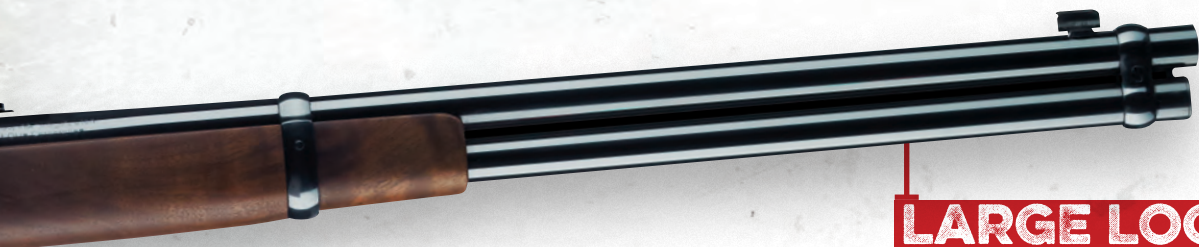

## LARGE LOOP CARBINE

- **WALNUT STRAIGHT GRIP STOCK** with a satin finish that's velvet smooth to the touch
- **CLASSIC CARBINE-STYLE FOREARM** with blued steel barrel band for the timeless look and feel of the original Model 1892® carbine
- **BLUED STEEL CARBINE STRAP BUTTPLATE** slips into your shoulder for a solid hold
- **LARGE LEVER LOOP** that's authentic for a Hollywood saddle carbine

- **LADDER REAR SIGHT WITH MARBLE ARMS® FRONT SIGHT** get you on target quickly
- **STEEL LOADING GATE** for smoother loading
- **TOP TANG** is drilled and tapped for an optional receiver mounted peep sight for a more precise sight picture

ITEM NUMBER	CALIBER	MAGAZINE CAPACITY	BARREL LENGTH	OVERALL LENGTH	LENGTH OF PULL	DROP AT COMB	DROP AT HEEL	NOMINAL WT. (LBS)	RATE OF TWIST	SUGGESTED RETAIL
<b>MODEL 1892 SHORT RIFLE</b>										
534162124	44 Rem Mag	10	20"	37 1/2"	12 3/4"	1 1/8"	1 3/4"	6	26"	\$1,069.99
534162141	45 Colt	10	20"	37 1/2"	12 3/4"	1 1/8"	1 3/4"	6	26"	1,069.99
534162137	357 Mag	10	20"	37 1/2"	12 3/4"	1 1/8"	1 3/4"	6	26"	1,069.99
<b>MODEL 1892 LARGE LOOP CARBINE</b>										
534190124	44 Rem Mag	10	20"	37 1/2"	12 3/4"	1 1/8"	1 3/4"	6	26"	\$1,259.99
534190140	44-40 Win	10	20"	37 1/2"	12 3/4"	1 1/8"	1 3/4"	6	26"	1,259.99
534190137	357 Mag	10	20"	37 1/2"	12 3/4"	1 1/8"	1 3/4"	6	26"	1,259.99
534190141	45 Colt	10	20"	37 1/2"	12 3/4"	1 1/8"	1 3/4"	6	26"	1,259.99

# TAKE 'EM DOWN.

PERFECT FOR BIG AND  
EVEN BIGGER GAME.



**PACHMAYR® DECELERATOR®  
RECOIL PAD** is a welcome  
addition to models chambered  
in 450 Marlin.

# MODEL 94



If you want a truly compact rifle that you can stuff into your backpack, wrap in your bedroll, strap to your ATV or tuck behind the seat of your truck, boat or bush plane, the **MODEL 94® TAKEDOWN** comes apart with just a quick twist into two compact components — the barrel assembly and the stocked receiver assembly. **REASSEMBLY** is easy. Put the two pieces together, give the end of the magazine tube a few turns and you instantly have a full-length rifle with the same superb accuracy as the other Model 94 models.



**BARREL PORTS** ease the sting of “felt recoil” on models chambered in 450 Marlin.

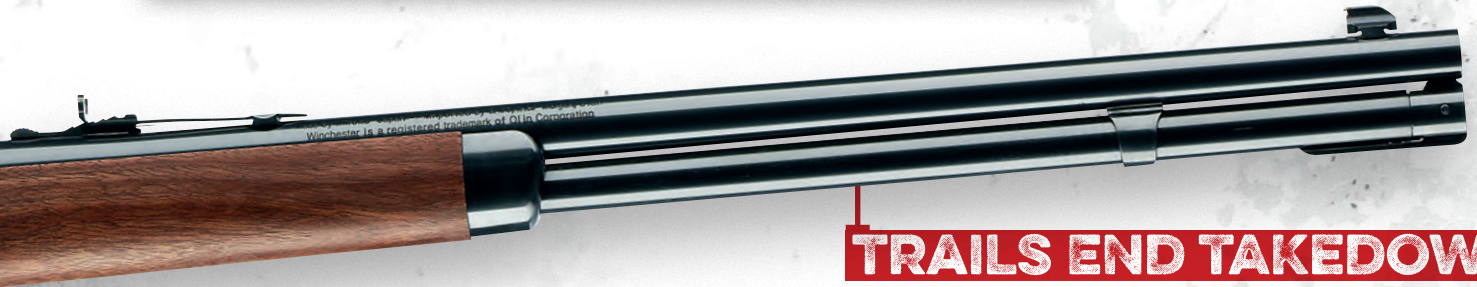

## TRAILS END TAKEDOWN

- **WALNUT STOCK** with satin finish, authentic straight-grip styling and a blued steel forearm cap offer a nostalgic look
- **TRADITIONAL TAKEDOWN MECHANISM** is fast and easy to operate
- **TRIPLE-CHECKED BUTTON RIFLED BARREL** for the ultimate in accuracy and precision
- **ROUND LOCKING BOLT TRUNNIONS** help ensure a smooth, quick lever throw
- **BOLT RELIEF CUT** reduces hammer drag for smoother cocking
- **RADIUSED LEVER EDGES** give added protection to your fingers

- **HAMMER** is drilled and tapped for a **KNURLED HAMMER SPUR EXTENSION** (included) to aid in cocking and decocking the hammer when a scope is mounted
- **MARBLE ARMS® FRONT SIGHT AND ADJUSTABLE SEMI-BUCKHORN REAR SIGHT** get you on target quickly
- **STEEL LOADING GATE** for smoother loading
- **ARTICULATED CARTRIDGE STOP** improves feeding reliability without damaging cartridges
- **DRILLED AND TAPPED FOR SCOPE MOUNTS** to easily attach your favorite optics



## CARBINE

- **WALNUT STOCK** with satin finish, authentic straight-grip styling and a blued steel forearm band offer a nostalgic look
- **BLUED STEEL CARBINE STRAP BUTTPLATE** for smooth and easy shouldering
- **TRIPLE-CHECKED BUTTON RIFLED BARREL** for the ultimate in accuracy and precision
- **ROUND LOCKING BOLT TRUNNIONS** help ensure a smooth, quick lever throw
- **BOLT RELIEF CUT** reduces hammer drag for smoother cocking
- **RADIUSED LEVER EDGES** give added protection to your fingers

- **HAMMER** is drilled and tapped for a **KNURLED HAMMER SPUR EXTENSION** (included) to aid in cocking and decocking the hammer when a scope is mounted
- **MARBLE ARMS® FRONT SIGHT AND ADJUSTABLE SEMI-BUCKHORN REAR SIGHT** get you on target quickly
- **STEEL LOADING GATE** for smoother loading
- **ARTICULATED CARTRIDGE STOP** improves feeding reliability without damaging cartridges
- **DRILLED AND TAPPED FOR SCOPE MOUNTS** to easily attach your favorite optics

ITEM NUMBER	CALIBER	MAGAZINE CAPACITY	BARREL LENGTH	OVERALL LENGTH	LENGTH OF PULL	DROP AT COMB	DROP AT HEEL	NOMINAL WT. (LBS)	RATE OF TWIST	SUGGESTED RETAIL
<b>MODEL 94 TRAILS END TAKEDOWN</b>										
534191114	30-30 Win	6	20"	38"	13 1/2"	1 1/4"	1 3/4"	6 3/4	12"	\$1,459.99
534191117	38-55 Win	6	20"	38"	13 1/2"	1 1/4"	1 3/4"	6 3/4	15"	1,459.99
534191160	450 Marlin	6	20"	38"	13 1/2"	1 1/4"	1 3/4"	6 3/4	20"	1,459.99
<b>MODEL 94 CARBINE</b>										
534199114	30-30 Win	7	20"	38"	13 1/2"	1 1/4"	1 3/4"	6 1/2	12"	\$1,199.99
534199117	38-55 Win	7	20"	38"	13 1/2"	1 1/4"	1 3/4"	6 1/2	15"	1,199.99

# LEVERAGE.

OWN THE WORLD'S MOST  
LEGENDARY LEVER-ACTION.



**PACHMAYR®  
DECELERATOR®  
RECOIL PAD**  
is a welcome  
addition  
to models  
chambered in  
450 Marlin.



**MODEL 94**

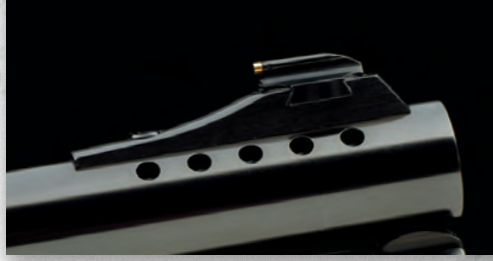

**BARREL PORTS** ease the sting of “felt recoil” on models chambered in 450 Marlin.



## SHORT RIFLE

- **WALNUT STOCK** with satin finish, authentic straight-grip styling and a blued steel forearm cap offer a nostalgic look
- **SHOTGUN STYLE BUTTPLATE** for smooth and easy shouldering
- **TRIPLE-CHECKED BUTTON RIFLED BARREL** for the ultimate in accuracy and precision
- **ROUND LOCKING BOLT TRUNNIONS** help ensure a smooth, quick lever throw
- **BOLT RELIEF CUT** reduces hammer drag for smoother cocking
- **RADIUSED LEVER EDGES** give added protection to your fingers
- **HAMMER** is drilled and tapped for a **KNURLED HAMMER SPUR EXTENSION** (included) to aid in cocking and decocking the hammer when a scope is mounted
- **MARBLE ARMS® FRONT SIGHT AND ADJUSTABLE SEMI-BUCKHORN REAR SIGHT** get you on target quickly
- **STEEL LOADING GATE** for smoother loading
- **ARTICULATED CARTRIDGE STOP** improves feeding reliability without damaging cartridges
- **DRILLED AND TAPPED FOR SCOPE MOUNTS** to easily attach your favorite optics

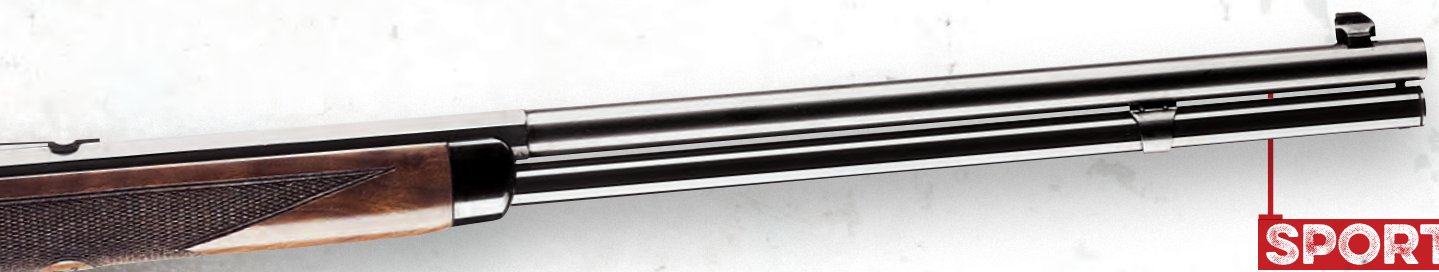

## SPORTER

- **WALNUT STOCK** with satin finish, authentic straight-grip styling, bordered cut checkering and a blued steel forearm cap offer a nostalgic look
- **BLUED CRESCENT BUTTPLATE** slips firmly into your shoulder for a solid hold
- **TRIPLE-CHECKED HALF ROUND/HALF OCTAGON BUTTON RIFLED BARREL** for the ultimate in accuracy and precision
- **ROUND LOCKING BOLT TRUNNIONS** help ensure a smooth, quick lever throw
- **BOLT RELIEF CUT** reduces hammer drag for smoother cocking
- **RADIUSED LEVER EDGES** give added protection to your fingers
- **HAMMER** is drilled and tapped for a **KNURLED HAMMER SPUR EXTENSION** (included) to aid in cocking and decocking the hammer when a scope is mounted
- **MARBLE ARMS® FRONT SIGHT AND ADJUSTABLE SEMI-BUCKHORN REAR SIGHT** get you on target quickly
- **STEEL LOADING GATE** for smoother loading
- **ARTICULATED CARTRIDGE STOP** improves feeding reliability without damaging cartridges
- **DRILLED AND TAPPED FOR SCOPE MOUNTS** to easily attach your favorite optics

ITEM NUMBER	CALIBER	MAGAZINE CAPACITY	BARREL LENGTH	OVERALL LENGTH	LENGTH OF PULL	DROP AT COMB	DROP AT HEEL	NOMINAL WT. (LBS)	RATE OF TWIST	SUGGESTED RETAIL
<b>MODEL 94 SHORT RIFLE</b>										
534174114	30-30 Win	7	20"	38"	13 1/2"	1 1/4"	1 3/4"	6 3/4	12"	\$1,229.99
534174117	38-55 Win	7	20"	38"	13 1/2"	1 1/4"	1 3/4"	6 3/4	15"	1,229.99
534174160	450 Marlin	7	20"	38"	13 1/2"	1 1/4"	1 3/4"	6 3/4	20"	1,229.99
<b>MODEL 94 SPORTER</b>										
534178114	30-30 Win	8	24"	42 1/2"	13 1/2"	1 1/4"	1 3/4"	7 1/2	12"	\$1,399.99
534178117	38-55 Win	8	24"	42 1/2"	13 1/2"	1 1/4"	1 3/4"	7 1/2	15"	1,399.99

# XPR<sup>®</sup>

## XPRIENCE PERFORMANCE.

THE FEATURE PACKED XPR<sup>®</sup> CONTINUES THE DESIGN LEADERSHIP OF WINCHESTER REPEATING ARMS. USING ADVANCED MATERIALS AND THE LATEST TECHNOLOGY RESULTS IN AN ACCURATE AND RUGGED HUNTING RIFLE THAT WILL GET THE JOB DONE EVERY TIME. BEST OF ALL, THE XPR IS PRICED JUST RIGHT FOR TODAY'S HUNTER. TAKE YOUR PICK OF BLACK COMPOSITE OR MOSSY OAK<sup>®</sup> BREAK-UP COUNTRY<sup>®</sup> CAMO.

### M.O.A.<sup>™</sup> TRIGGER SYSTEM

#### HARDENED STEEL COMPONENTS

The trigger housing and all internal components in the XPR<sup>®</sup> rifle's M.O.A. trigger are constructed of polished and hardened carbon steel, many with a blued finish for added durability and corrosion resistance. The sear and actuator are **NICKEL TEFLON<sup>®</sup>** coated for reduced friction and added wear resistance.

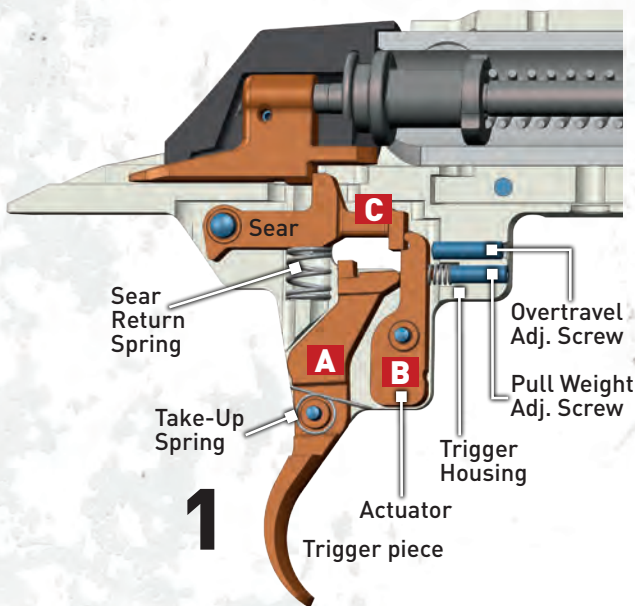

#### (1) M.O.A. TRIGGER SYSTEM

The XPR<sup>®</sup> rifle's M.O.A. Trigger System works on the simple principle of the pivoting lever. Pictured above are the trigger piece (A), actuator (B), and sear (C).

#### (2) 2:1 MECHANICAL ADVANTAGE

The M.O.A.'s trigger piece offers a wide, smooth face to better distribute finger pressure for a lighter, more sensitive feel. Because of its geometry and 2:1 mechanical advantage, the trigger piece travels only half the distance of the actuator (2X). Since this distance is cut in half, the perception of creep and overtravel are virtually eliminated. This means that your "feel" for the trigger is greatly enhanced, and thus your effective accuracy, both in the field and off the bench are improved.

#### ZERO TAKE-UP

Take-up is the distance the trigger piece travels prior to the sear moving toward release and the shooter feeling resistance. The XPR<sup>®</sup> M.O.A. Trigger System uses a spring to eliminate take-up by keeping the trigger piece in constant contact with the actuator. Unlike many competitors' designs, the unique geometry of the M.O.A. pre-loads the entire trigger system to bias out normal manufacturing tolerances.

#### ZERO CREEP

Creep is the perceptible movement of the trigger prior to the release of the firing pin and has a negative influence on accuracy, causing inconsistency and uncertainty during the pull of the trigger. Creep contributes to jerking the trigger, thus adding to movement of the gun during firing. The 2:1 mechanical advantage created by this unique design geometry has virtually eliminated creep in the XPR<sup>®</sup> rifle's M.O.A. Trigger.

#### ZERO OVERTRAVEL

Overtravel is the rearward movement of the trigger after the firing pin has been released. It can actually jar the gun away from its intended point of aim and is very distracting to the shooter. The XPR<sup>®</sup> adjustable M.O.A. Trigger System is set at the factory for a crisp break at about 3 1/2 pounds with no perceptible overtravel. When the sear drops, the trigger stops. Where you aim is where you shoot.

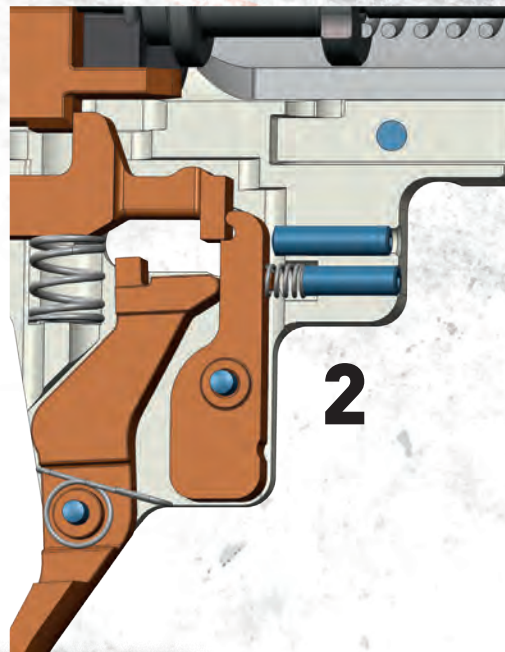

**"I HUNT IN TOUGH CONDITIONS SO I NEED A RIFLE THAT WILL HOLD UP IN BRUTAL WEATHER, RUGGED TERRAIN AND ALWAYS PERFORM. ACCURACY AND RELIABILITY ARE ABSOLUTELY NECESSARY, AND MY FIRST CHOICE IS THE WINCHESTER XPR."**

— Melissa Bachman • *Winchester Deadly Passion*

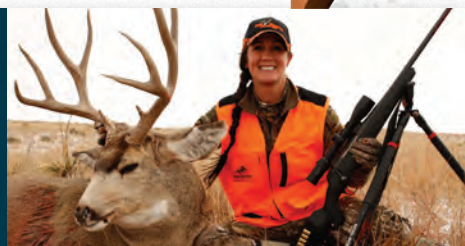



Every XPR® has a **TWO-POSITION SAFETY** that's convenient to operate with the thumb of your firing hand. The safety's design fully retracts the trigger away from the actuator. Located just in front of the safety button, the **BOLT RELEASE BUTTON** allows the action to cycle unfired cartridges while the safety is on. The **COCKING INDICATOR** on the bolt shroud gives you both a tactile and visual reference of the rifle's cocked/uncocked condition.



The robust **XPR® BOLT** is crafted from chromoly steel barstock and is through-hardened during heat-treatment. The bolt design offers three front locking lugs and a short 60-degree lift for improved scope clearance when cycling. The full-diameter bolt body creates a more rigid component. It is then coated with **NICKEL TEFLON®** for smoother operation and added corrosion resistance. The one-piece bolt handle is sculpted to give a more positive grip. The bolt can be fieldstripped in just seconds without special tools for cleaning and lubrication.



The one-piece **TRIGGER GUARD** and **MAGAZINE FRAME** design offers a generous guard opening for use with gloves. The **DETACHABLE BOX MAGAZINE** is constructed of a light yet rugged polymer and securely latches at both the front and rear. A single stack design that feeds cartridges in a straight line to the chamber; the magazine's capacity is three rounds in both magnum and standard calibers. Additional magazines can be easily carried in a pocket or pack.

Every XPR® features a durable **PERMA-COTE™** matte black finish applied to the barrel, receiver and bolt handle to protect from wear and corrosion and to keep your rifle looking sharp for years to come.



The **CHROMOLY STEEL BARREL** on the XPR® rifle is precisely button-rifled to create outstanding accuracy with a wide variety of bullet weights and types. Every barrel is thermally stress relieved to ensure straight and true accuracy, even during long strings of fire. The **BARREL NUT** keeps the entire barrel/receiver assembly precisely aligned and allows for more accurate headspace control during manufacture. This means there is nothing to shift out of position and degrade accuracy. The entire barrel is **FREE-FLOATING** to eliminate any accuracy robbing pressure points.



The **XPR® RECEIVER** is chromoly steel barstock that's precision machined and through-hardened during heat-treating to create a strong, stiff and solid receiver capable of delivering pinpoint accuracy. The ejection port is generously sized for more reliable ejection and easier access when loading single cartridges by hand. Two socket head action screws allow the receiver to be precisely torqued in the stock for maximum accuracy. The receiver is drilled and tapped for robust 8-40 screws, creating a more secure mounting for today's larger, high-magnification scopes.



The XPR® rifle's **ADVANCED POLYMER STOCK** comes in a choice of subdued finishes with textured panels on the fore-end and pistol grip to improve grip in cold, wet weather. The fore-end has rounded edges plus a slightly flattened bottom profile for comfortable shooting from any position. This flattened profile also optimizes stability when firing off sandbags or a rest.

A critical feature of any high-powered rifle is how the action and barrel are set in the stock. The XPR rifle's receiver nestles onto **FLAT PROFILE INTERFACE PADS** and into a cross-mounted recoil lug to resist flex and twist when firing. The XPR will hold its zero under the most adverse conditions.



Every XPR® features a **RECESSED TARGET-STYLE CROWN** at the muzzle to protect the rifling from nicks and dings. Each bullet exits the barrel uniformly for the ultimate in downrange accuracy.

The **INFLEX TECHNOLOGY RECOIL PAD** has specially-shaped internal rib structures that redirect the recoil impulse, moving the comb down and away from your face. The ideally contoured contact area on the XPR® rifle offers optimal protection against "felt recoil," even when shooting today's magnum loads.

Selected models of the XPR® are also available in a **COMPACT VERSION, WITH A SHORTER 13" LENGTH OF PULL**, making it a perfect fit for younger shooters and those of smaller stature.

# THE CAMO XPR.<sup>®</sup>

DRESSED FOR SUCCESS IN  
MOSSY OAK'S<sup>®</sup> LATEST CAMO.



NEW

M.O.A.<sup>™</sup>  
TRIGGER SYSTEM

HUNTER  
MOUNTAIN COUNTRY RANGE



M.O.A.<sup>™</sup>  
TRIGGER SYSTEM

HUNTER  
BREAK-UP COUNTRY

# XPR<sup>®</sup>



**WINCHESTER<sup>®</sup> DEER SEASON XP<sup>®</sup>**  
**SHOOT THE BIGGER TIP FOR BIGGER**  
**IMPACT ON THE BIGGEST BUCKS.**

Deer Season XP<sup>®</sup> is the first ammunition ever designed specifically by Winchester for hunting deer. The Extreme Point<sup>®</sup> bullets feature a radically new, large-tip-diameter technology to deliver massive energy immediately on impact to put deer down quickly.



**NEW**



# HUNTER & HUNTER COMPACT

- **M.O.A. TRIGGER SYSTEM** with zero take-up, zero creep and zero overtravel gives you outstanding accuracy
- **BOLT UNLOCK BUTTON** allows the chamber to be unloaded with the thumb safety in the on-safe position
- **NICKEL TEFLON®** on the bolt body offers smoother operation and added corrosion resistance
- **DETACHABLE BOX MAGAZINE** is a single stack design constructed from a rugged polymer for greater reliability
- **ADVANCED POLYMER STOCK IN TWO POPULAR MOSSY OAK® CAMO PATTERNS** including Mountain Country Range and Break-Up Country®. Textured panels help improve wet weather grip, while the flattened fore-end profile improves stability from sandbags or a benchrest
- **SHORTER 13" LENGTH OF PULL OF THE COMPACT MODEL** makes it perfect for younger shooters and those of smaller stature.
- **PERMA-COTE™ MATTE BLACK METAL SURFACES** (Matte gray metal surfaces on Hunter Compact models) minimize glare to help prevent game-spooking reflections and protect from corrosion
- **INFLEX TECHNOLOGY RECOIL PAD** directs energy down and away from your cheek to reduce "felt recoil"
- **STEEL RECOIL LUG** is inletted into the stock to prevent the receiver from twisting under recoil for more reliable and predictable long-range accuracy
- **RECEIVER IS MACHINED FROM SOLID STEEL BAR STOCK** and through-hardened during heat treating for longer life and enhanced accuracy
- **TWO-POSITION THUMB SAFETY** and a cocking indicator show the XPR® rifle's safety status at a glance or by feel
- **BUTTON-RIFLED, FREE-FLOATED STEEL BARRÉL** is thermally stress-relieved then precisely aligned and headspaced during assembly via the barrel nut
- **RECESSED TARGET CROWN** protects the muzzle rifling from wear and impact damage to help maintain greater accuracy

	ITEM NUMBER	CALIBER	MAGAZINE CAPACITY	BARREL LENGTH	OVERALL LENGTH	LENGTH OF PULL	DROP AT COMB	DROP AT HEEL	NOMINAL WT. (LBS)	RATE OF TWIST	SUGGESTED RETAIL
<b>XPR HUNTER COMPACT BREAK-UP COUNTRY</b>											
<b>NEW</b>	535721212	243 Win	3	20"	39 1/4"	13"	1/2"	3/4"	6 1/2	10"	\$599.99
<b>NEW</b>	535721218	7mm-08 Rem	3	20"	39 1/4"	13"	1/2"	3/4"	6 1/2	9 1/2"	599.99
<b>NEW</b>	535721220	308 Win	3	20"	39 1/4"	13"	1/2"	3/4"	6 1/2	12"	599.99
<b>NEW</b>	535721264	270 WSM	3	22"	41 1/4"	13"	1/2"	3/4"	6 3/4	10"	599.99
<b>NEW</b>	535721255	300 WSM	3	22"	41 1/4"	13"	1/2"	3/4"	6 3/4	10"	599.99
<b>NEW</b>	535721277	325 WSM	3	22"	41 1/4"	13"	1/2"	3/4"	6 3/4	10"	599.99
<b>XPR HUNTER MOUNTAIN COUNTRY RANGE</b>											
<b>NEW</b>	535722212	243 Win	3	22"	42"	13 3/4"	1/2"	3/4"	6 3/4	10"	\$599.99
<b>NEW</b>	535722218	7mm-08 Rem	3	22"	42"	13 3/4"	1/2"	3/4"	6 3/4	9 1/2"	599.99
<b>NEW</b>	535722220	308 Win	3	22"	42"	13 3/4"	1/2"	3/4"	6 3/4	12"	599.99
<b>NEW</b>	535722264	270 WSM	3	24"	44"	13 3/4"	1/2"	3/4"	7	10"	599.99
<b>NEW</b>	535722255	300 WSM	3	24"	44"	13 3/4"	1/2"	3/4"	7	10"	599.99
<b>NEW</b>	535722277	325 WSM	3	24"	44"	13 3/4"	1/2"	3/4"	7	10"	599.99
<b>NEW</b>	535722226	270 Win	3	24"	44 1/2"	13 3/4"	1/2"	3/4"	7	10"	599.99
<b>NEW</b>	535722228	30-06	3	24"	44 1/2"	13 3/4"	1/2"	3/4"	7	10"	599.99
<b>NEW</b>	535722230	7mm Rem Mag	3	26"	46 1/2"	13 3/4"	1/2"	3/4"	7 1/4	9 1/2"	599.99
<b>NEW</b>	535722233	300 Win Mag	3	26"	46 1/2"	13 3/4"	1/2"	3/4"	7 1/4	10"	599.99
<b>NEW</b>	535722236	338 Win Mag	3	26"	46 1/2"	13 3/4"	1/2"	3/4"	7 1/4	10"	599.99
<b>XPR HUNTER BREAK-UP COUNTRY</b>											
	535704212	243 Win	3	22"	42"	13 3/4"	1/2"	3/4"	6 3/4	10"	\$599.99
	535704218	7mm-08 Rem	3	22"	42"	13 3/4"	1/2"	3/4"	6 3/4	9 1/2"	599.99
	535704220	308 Win	3	22"	42"	13 3/4"	1/2"	3/4"	6 3/4	12"	599.99
	535704264	270 WSM	3	24"	44"	13 3/4"	1/2"	3/4"	7	10"	599.99
	535704255	300 WSM	3	24"	44"	13 3/4"	1/2"	3/4"	7	10"	599.99
	535704277	325 WSM	3	24"	44"	13 3/4"	1/2"	3/4"	7	10"	599.99
	535704226	270 Win	3	24"	44 1/2"	13 3/4"	1/2"	3/4"	7	10"	599.99
	535704228	30-06 Sprg	3	24"	44 1/2"	13 3/4"	1/2"	3/4"	7	10"	599.99
	535704230	7mm Rem Mag	3	26"	46 1/2"	13 3/4"	1/2"	3/4"	7 1/4	9 1/2"	599.99
	535704233	300 Win Mag	3	26"	46 1/2"	13 3/4"	1/2"	3/4"	7 1/4	10"	599.99
	535704236	338 Win Mag	3	26"	46 1/2"	13 3/4"	1/2"	3/4"	7 1/4	10"	599.99

# THE COMPACT XPR.<sup>®</sup>

NOW EVERY SHOOTER CAN ENJOY THE XPR XPRIENCE.



# XPR

	ITEM NUMBER	CALIBER	MAGAZINE CAPACITY	BARREL LENGTH	OVERALL LENGTH	LENGTH OF PULL	DROP AT COMB	DROP AT HEEL	NOMINAL WT. (LBS)	RATE OF TWIST	SUGGESTED RETAIL
<b>XPR COMPACT</b>											
<b>NEW</b>	535720212	243 Win	3	.20"	39 1/4"	13"	1/2"	3/4"	6 1/2	10"	\$549.99
<b>NEW</b>	535720218	7mm-08 Rem	3	20"	39 1/4"	13"	1/2"	3/4"	6 1/2	9 1/2"	549.99
<b>NEW</b>	535720220	308 Win	3	20"	39 1/4"	13"	1/2"	3/4"	6 1/2	12"	549.99
<b>NEW</b>	535720264	270 WSM	3	22"	41 1/4"	13"	1/2"	3/4"	6 3/4	10"	549.99
<b>NEW</b>	535720255	300 WSM	3	22"	41 1/4"	13"	1/2"	3/4"	6 3/4	10"	549.99
<b>NEW</b>	535720277	325 WSM	3	22"	41 1/4"	13"	1/2"	3/4"	6 3/4	10"	549.99



**NEW** **M.O.A.™**  
TRIGGER SYSTEM  
**COMPACT**

- **M.O.A. TRIGGER SYSTEM** with zero take-up, zero creep and zero overtravel gives you outstanding accuracy
- **BOLT UNLOCK BUTTON** allows the chamber to be unloaded with the thumb safety in the on-safe position
- **NICKEL TEFLON®** on the bolt body offers smoother operation and added corrosion resistance
- **DETACHABLE BOX MAGAZINE** is a single stack design constructed from a rugged polymer for greater reliability
- **ADVANCED POLYMER STOCK** with textured panels help improve wet weather grip, while the flattened fore-end profile improves stability from sandbags or a benchrest
- **SHORTER 13" LENGTH OF PULL** makes it perfect for younger shooters and those of smaller stature.
- **PERMA-COTE™ MATTE GRAY METAL SURFACES** minimize glare to help prevent game-spooking reflections and protect from corrosion

- **INFLEX TECHNOLOGY RECOIL PAD** directs energy down and away from your cheek to reduce "felt recoil"
- **STEEL RECOIL LUG** is inletted into the stock to prevent the receiver from twisting under recoil for more reliable and predictable long-range accuracy
- **RECEIVER IS MACHINED FROM SOLID STEEL BAR STOCK** and through-hardened during heat treating for longer life and enhanced accuracy
- **TWO-POSITION THUMB SAFETY** and a cocking indicator show the XPR® rifle's safety status at a glance or by feel
- **BUTTON-RIFLED, FREE-FLOATED STEEL BARREL** is thermally stress-relieved then precisely aligned and headspaced during assembly via the barrel nut
- **RECESSED TARGET CROWN** protects the muzzle rifling from wear and impact damage to help maintain greater accuracy

**M.O.A.™**  
TRIGGER SYSTEM

**XPR**

- **M.O.A. TRIGGER SYSTEM** with zero take-up, zero creep and zero overtravel gives you outstanding accuracy
- **BOLT UNLOCK BUTTON** allows the chamber to be unloaded with the thumb safety in the on-safe position
- **NICKEL TEFLON®** on the bolt body offers smoother operation and added corrosion resistance
- **DETACHABLE BOX MAGAZINE** is a single stack design constructed from a rugged polymer for greater reliability
- **ADVANCED POLYMER STOCK** with textured panels help improve wet weather grip, while the flattened fore-end profile improves stability from sandbags or a benchrest
- **PERMA-COTE™ MATTE BLACK METAL SURFACES** minimize glare to help prevent game-spooking reflections and protect from corrosion

- **INFLEX TECHNOLOGY RECOIL PAD** directs energy down and away from your cheek to reduce "felt recoil"
- **STEEL RECOIL LUG** is inletted into the stock to prevent the receiver from twisting under recoil for more reliable and predictable long-range accuracy
- **RECEIVER IS MACHINED FROM SOLID STEEL BAR STOCK** and through-hardened during heat treating for longer life and enhanced accuracy
- **TWO-POSITION THUMB SAFETY** and a cocking indicator show the XPR® rifle's safety status at a glance or by feel
- **BUTTON-RIFLED, FREE-FLOATED STEEL BARREL** is thermally stress-relieved then precisely aligned and headspaced during assembly via the barrel nut
- **RECESSED TARGET CROWN** protects the muzzle rifling from wear and impact damage to help maintain greater accuracy

	ITEM NUMBER	CALIBER	MAGAZINE CAPACITY	BARREL LENGTH	OVERALL LENGTH	LENGTH OF PULL	DROP AT COMB	DROP AT HEEL	NOMINAL WT. (LBS)	RATE OF TWIST	SUGGESTED RETAIL
<b>XPR</b>	535700212	243 Win	3	22"	42"	13 3/4"	1/2"	3/4"	6 3/4	10"	\$549.99
	535700218	7mm-08 Rem	3	22"	42"	13 3/4"	1/2"	3/4"	6 3/4	9 1/2"	549.99
	535700220	308 Win	3	22"	42"	13 3/4"	1/2"	3/4"	6 3/4	12"	549.99
	535700264	270 WSM	3	24"	44"	13 3/4"	1/2"	3/4"	7	10"	549.99
	535700255	300 WSM	3	24"	44"	13 3/4"	1/2"	3/4"	7	10"	549.99
	535700277	325 WSM	3	24"	44"	13 3/4"	1/2"	3/4"	7	10"	549.99
	535700226	270 Win	3	24"	44 1/2"	13 3/4"	1/2"	3/4"	7	10"	549.99
	535700228	30-06 Sprg	3	24"	44 1/2"	13 3/4"	1/2"	3/4"	7	10"	549.99
	535700230	7mm Rem Mag	3	26"	46 1/2"	13 3/4"	1/2"	3/4"	7 1/4	9 1/2"	549.99
	535700233	300 Win Mag	3	26"	46 1/2"	13 3/4"	1/2"	3/4"	7 1/4	10"	549.99
	535700236	338 Win Mag	3	26"	46 1/2"	13 3/4"	1/2"	3/4"	7 1/4	10"	549.99

(SCOPE AND MOUNTS SHOWN NOT INCLUDED.)

# MODEL 70<sup>®</sup>

## FOREVER THE RIFLEMAN'S RIFLE.

NO OTHER BOLT-ACTION IN HISTORY CAN INSPIRE THE PASSION, COMMAND THE LOYALTY OR CREATE A SENSE OF EXCITEMENT AMONG DEDICATED MARKSMEN LIKE THE MODEL 70<sup>®</sup>. SINCE 1936, IT'S BEEN THE BENCHMARK AGAINST WHICH EVERY OTHER BOLT-ACTION RIFLE IS MEASURED. VISIT YOUR WINCHESTER REPEATING ARMS DEALER AND DISCOVER THE RIFLEMAN'S RIFLE FOR YOURSELF.



### STAINLESS STEEL COMPONENTS

The trigger housing and all internal components of the M.O.A. Trigger System are constructed of durable, corrosion-resistant stainless steel.

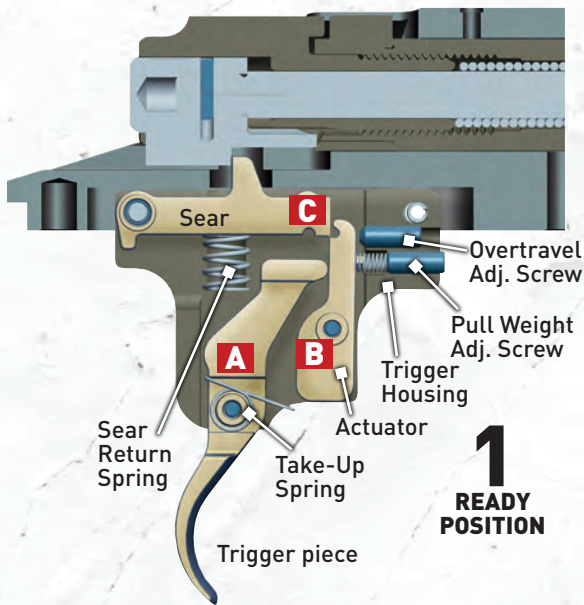

### (1) M.O.A. TRIGGER SYSTEM

The Model 70<sup>®</sup> rifle's M.O.A. Trigger System works on the simple principle of the pivoting lever. Pictured above are the trigger piece (A), actuator (B), and sear (C). The housing and all internal parts, pins and springs are precision crafted from stainless steel. In addition, the sear and actuator are Slick Shot<sup>®</sup> electroless nickel Teflon<sup>®</sup> coated for corrosion resistance and smoother operation.

### (2) 2:1 MECHANICAL ADVANTAGE

The M.O.A.'s trigger piece offers a wide, smooth face to better distribute finger pressure for a lighter, more sensitive feel. Because of its geometry and 2:1 mechanical advantage, the trigger piece travels only half the distance of the actuator (2X). Since this distance is cut in half, the perception of creep and overtravel are virtually eliminated.

### ZERO TAKE-UP

Take-up is the distance the trigger piece travels prior to the sear moving toward release and the shooter feeling resistance. The M.O.A. Trigger System uses a spring to eliminate take-up by keeping the trigger piece in constant contact with the actuator. Unlike competitors' designs, the unique geometry of the M.O.A. pre-loads the entire trigger system to bias out normal manufacturing tolerances.

### ZERO CREEP

Creep is the perceptible movement of the trigger prior to the release of the firing pin and has a negative influence on accuracy causing inconsistency and uncertainty during the pull of the trigger. Creep contributes to jerking the trigger, thus adding to movement of the gun during firing. The 2:1 mechanical advantage created by the M.O.A. Trigger's unique design geometry has virtually eliminated creep in the Model 70<sup>®</sup> M.O.A. Trigger.

### ZERO OVERTRAVEL

Overtravel is the rearward movement of the trigger after the firing pin has been released. It can actually jar the gun away from its intended point of aim and is very distracting to the shooter. The Model 70<sup>®</sup> M.O.A. Trigger System is set at the factory to have no perceptible overtravel. When the sear drops, the trigger stops. Where you aim is where you shoot.

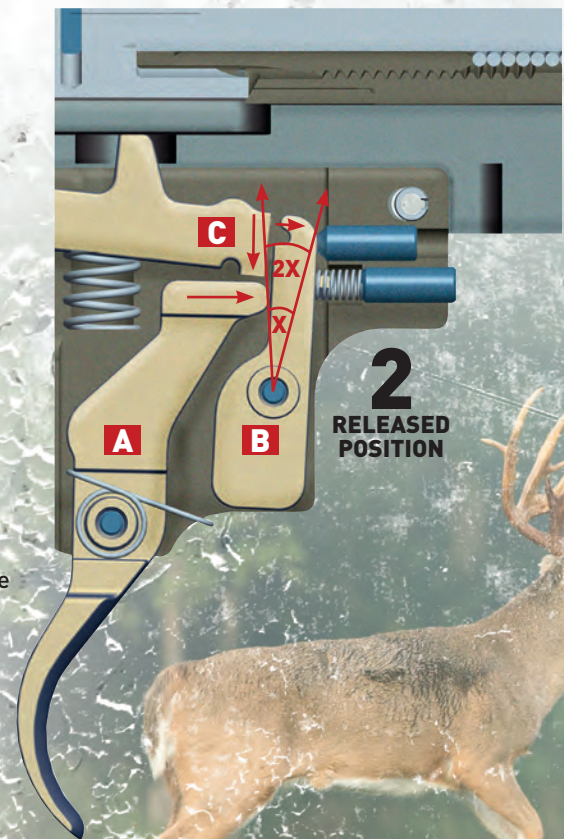

# MODEL 70<sup>®</sup>



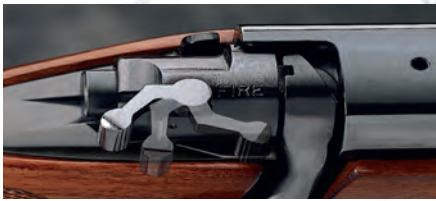

Every Model 70® has a **THREE-POSITION SAFETY** that is convenient to operate with the thumb of your firing hand. The design retracts the firing pin away from the sear. When the safety selector is in the middle position, the action can still be operated, allowing unfired cartridges to be cycled with the safety on. It's smooth to engage and easily identifies, by sight and feel, the safety status of the rifle.



**A BLADE-TYPE EJECTOR** gives you full control when ejecting a fired case. Pull the bolt back slowly and the empty case pops out gently — perfect for target shooters and varminters. Pull the bolt back smartly and the empty case clears the port with greater force.



If there were a single feature responsible for the Model 70® rifle being labeled the "Bolt-Action Rifle of the Century," it would be the classic Pre-'64 style **CONTROLLED ROUND FEED AND CLAW EXTRACTOR (CRF)** bolt design. The massive claw extractor secures the cartridge's base, exerting full control from the very moment it leaves the magazine and enters the chamber, gripping it tightly until it's fully ejected. This time-proven design allows an unfired cartridge to be extracted even if it is not yet fully chambered.

**THE STEEL RECEIVER IS FORGED** for superior material properties. Each forging is precision machined to create a strong, stiff and solid receiver that resists flexing and delivers top accuracy over a lifetime of shooting. The bottom profile of the Model 70® receiver is flat to offer more surface area for bedding. It's then bedded at the front and rear to eliminate shifts in zero and preserve pinpoint accuracy. The flat bottom contour also resists twisting inside the stock during firing, making it superior to the competitions' round bottom receivers.



**THE INTEGRAL RECOIL LUG** on the Model 70® is actually forged and machined as part of the receiver. It's a hefty block of solid steel, not a mere washer or tab that's just sandwiched between the barrel and the action during assembly. This allows the barrel to be trued in perfect alignment to the front ring of the receiver for greater accuracy. There is nothing to move, settle or shift the barrel out of alignment, ever. It's what makes a Model 70 rifle shoot straight and true, year after year.

The trigger guard and magazine frame of each Model 70® rifle feature a solid, **ONE-PIECE BOTTOM METAL** supporting the action through the magazine well. This added rigidity contributes to accuracy and integrity better than two-piece systems. The hinged magazine floorplate speeds unloading of the cartridges to avoid having to cycle them through the action. The action and trigger guard are held in place by stout hex head screws.



You can expect **1 MOA ACCURACY** for three-shot groups from your Model 70® rifle using high-quality ammo and optics under suitable weather and range conditions. That's just an inch at a full 100 yards.

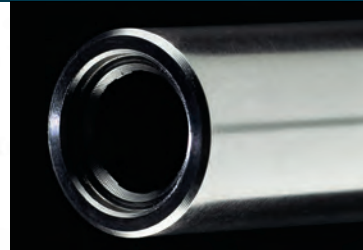

Every Model 70® features a **RECESSED TARGET CROWN** at the muzzle to protect the rifling from nicks and dings. Each bullet exits the barrel uniformly, with ultimate precision.

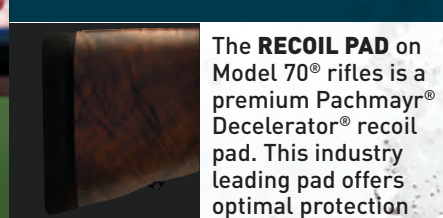

The **RECOIL PAD** on Model 70® rifles is a premium Pachmayr® Decelerator® recoil pad. This industry leading pad offers optimal protection against "felt recoil."

Critical to rifle accuracy is how the barrel is made and set in the stock. Most Model 70® barrels are **COLD HAMMER-FORGED** — from a solid billet of steel, shaped by massive rotary hammers over a mandrel to create the rifling. Then each barrel is stress relieved to ensure top accuracy, even during the heat of long strings of fire. Every Model 70 barrel is **FREE-FLOATING** in the stock so that no part of the fore-end touches the barrel, because pressure from contacting the stock adversely influences accuracy.

# OWN AN ICON.

## THE LEGENDARY MODEL 70 IS EVERYTHING A RIFLE SHOULD BE.

MODEL<sup>®</sup>  
70



ITEM NUMBER	CALIBER	MAGAZINE CAPACITY	BARREL LENGTH	OVERALL LENGTH	LENGTH OF PULL	DROP AT COMB	DROP AT HEEL	NOMINAL WT. (LBS)	RATE OF TWIST	SUGGESTED RETAIL
<b>MODEL 70 SUPER GRADE</b>										
535203264	270 WSM	3	24"	44 1/4"	13 3/4"	1/2"	1/2"	8	10"	\$1,479.99
535203255	300 WSM	3	24"	44 1/4"	13 3/4"	1/2"	1/2"	8	10"	1,479.99
535203226	270 Win	5	24"	44 3/4"	13 3/4"	1/2"	1/2"	8 1/4	10"	1,439.99
535203228	30-06 Sprg	5	24"	44 3/4"	13 3/4"	1/2"	1/2"	8 1/4	10"	1,439.99
535203230	7mm Rem Mag	3	26"	46 3/4"	13 3/4"	1/2"	1/2"	8 1/2	9 1/2"	1,479.99
535203233	300 Win Mag	3	26"	46 3/4"	13 3/4"	1/2"	1/2"	8 1/2	10"	1,479.99
535203236	338 Win Mag	3	26"	46 3/4"	13 3/4"	1/2"	1/2"	8 1/2	10"	1,479.99
<b>MODEL 70 SPORTER</b>										
535202264	270 WSM	3	24"	44 1/4"	13 3/4"	1/2"	1/2"	7 1/4	10"	\$1,049.99
535202255	300 WSM	3	24"	44 1/4"	13 3/4"	1/2"	1/2"	7 1/4	10"	1,049.99
535202277	325 WSM	3	24"	44 1/4"	13 3/4"	1/2"	1/2"	7 1/4	10"	1,049.99
535202225	25-06 Rem	5	24"	44 3/4"	13 3/4"	1/2"	1/2"	7 1/4	10"	1,009.99
535202226	270 Win	5	24"	44 3/4"	13 3/4"	1/2"	1/2"	7 1/4	10"	1,009.99
535202228	30-06 Sprg	5	24"	44 3/4"	13 3/4"	1/2"	1/2"	7 1/4	10"	1,009.99
535202229	264 Win Mag	3	26"	46 3/4"	13 3/4"	1/2"	1/2"	7 3/4	9"	1,049.99
535202230	7mm Rem Mag	3	26"	46 3/4"	13 3/4"	1/2"	1/2"	7 3/4	9 1/2"	1,049.99
535202233	300 Win Mag	3	26"	46 3/4"	13 3/4"	1/2"	1/2"	7 3/4	10"	1,049.99
535202236	338 Win Mag	3	26"	46 3/4"	13 3/4"	1/2"	1/2"	7 3/4	10"	1,049.99

(SCOPE AND MOUNTS SHOWN NOT INCLUDED.)



## SUPER GRADE

- **GRADE IV / V FULL FANCY WALNUT STOCK WITH SHADOWLINE CHEEKPIECE** places your eye in perfect alignment with the scope
- **HIGHLY POLISHED METAL SURFACES** add style and elegance
- **STEEL ONE-PIECE BOTTOM METAL** with steel floorplate adds rigidity for better accuracy
- **ENGRAVED STEEL CROSSBOLT** adds strength, rigidity and a touch of stylish refinement
- **INLETTED SLING SWIVEL STUDS** allow you to attach your favorite sling
- **FORGED STEEL RECEIVER WITH INTEGRAL RECOIL LUG** is bedded front and rear to eliminate shifts in zero for exceptional long-range accuracy
- **PRE-'64 STYLE CONTROLLED ROUND FEED WITH CLAW EXTRACTOR** fully controls the cartridge from magazine, to chamber, to ejection
- **THREE-POSITION SAFETY** allows you to unload the chamber while on safe and shows safety status at a glance
- **COLD HAMMER-FORGED FREE-FLOATED BARREL** for years of pinpoint accuracy
- **RECESSED TARGET CROWN** enhances accuracy and protects the rifling
- **M.O.A. TRIGGER SYSTEM** with zero take-up, zero creep and zero overtravel gives you outstanding accuracy
- **BLADE-TYPE EJECTOR** for full control of ejection force
- **PACHMAYR® DECELERATOR® RECOIL PAD** for optimal protection against "felt recoil"



RAISED CHEEKPIECE

## SPORTER

- **SATIN FINISH GRADE I WALNUT STOCK WITH CUT CHECKERING AND DELUXE CHEEKPIECE** places your eye in perfect alignment with the scope
- **POLISHED METAL SURFACES** add style and elegance
- **STEEL SLING SWIVEL STUDS** allow you to attach your favorite sling
- **ALLOY ONE-PIECE BOTTOM METAL** adds rigidity for better accuracy
- **FORGED STEEL RECEIVER WITH INTEGRAL RECOIL LUG** is bedded front and rear to eliminate shifts in zero for exceptional long-range accuracy
- **PRE-'64 STYLE CONTROLLED ROUND FEED WITH CLAW EXTRACTOR** fully controls the cartridge from magazine, to chamber, to ejection
- **THREE-POSITION SAFETY** allows you to unload the chamber while on safe and shows safety status at a glance
- **COLD HAMMER-FORGED FREE-FLOATED BARREL** for years of pinpoint accuracy
- **RECESSED TARGET CROWN** enhances accuracy and protects the rifling
- **M.O.A. TRIGGER SYSTEM** with zero take-up, zero creep and zero overtravel gives you outstanding accuracy
- **BLADE-TYPE EJECTOR** for full control of ejection force
- **PACHMAYR® DECELERATOR® RECOIL PAD** for optimal protection against "felt recoil"

# POWER.

LIKE HAVING A LIGHTNING BOLT  
RIGHT AT YOUR FINGERTIPS.

MODEL<sup>®</sup>  
70



**"THE WINCHESTER MODEL 70 IS MORE THAN A TRADITION, MORE THAN AN ICON. IT IS THE AMERICAN EXPRESSION OF THE ULTIMATE RIFLEMAN'S RIFLE. DURABLE AND PORTABLE WITH RELIABLE, CONTROLLED ROUND FEEDING IN A CLASSIC CONFIGURATION — THE MODEL 70 KINDLES DREAMS OF HUNTING ADVENTURE."**

— Ron Spomer • *Winchester World of Whitetail*

ITEM NUMBER	CALIBER	MAGAZINE CAPACITY	BARREL LENGTH	OVERALL LENGTH	LENGTH OF PULL	DROP AT COMB	DROP AT HEEL	SIGHT RADIUS	NOMINAL WT. (LBS)	RATE OF TWIST	SUGGESTED RETAIL
<b>MODEL 70 SAFARI EXPRESS</b>											
535204161	375 H&H Mag	3	24"	44 3/4"	13 3/4"	1/2"	1/2"	18"	9	12"	\$1,559.99
535204139	416 Rem Mag	3	24"	44 3/4"	13 3/4"	1/2"	1/2"	18"	9	14"	1,559.99
535204144	458 Win Mag	3	24"	44 3/4"	13 3/4"	1/2"	1/2"	18"	9	14"	1,559.99



DOUBLE RECOIL LUGS



SAFARI EXPRESS DELUXE CHEEKPIECE



DOUBLE CROSS BOLTS



## SAFARI EXPRESS

- **SATIN FINISH GRADE I WALNUT STOCK WITH CUT CHECKERING AND DELUXE CHEEKPIECE** places your eye in perfect alignment with open sights or a scope
- **STEEL ONE-PIECE BOTTOM METAL WITH STEEL FLOORPLATE** adds rigidity for better accuracy
- **MATTE FINISHED METAL SURFACES** reduce glare
- **DUAL STEEL CROSSBOLTS** add strength, rigidity and a touch of stylish refinement
- **FORGED STEEL RECEIVER WITH DUAL RECOIL LUGS** is bedded front and rear to eliminate shifts in zero for exceptional long-range accuracy
- **PRE-'64 STYLE CONTROLLED ROUND FEED WITH CLAW EXTRACTOR** fully controls the cartridge from magazine, to chamber, to ejection

- **THREE-POSITION SAFETY** allows you to unload the chamber while on safe and shows safety status at a glance
- **COLD HAMMER-FORGED FREE-FLOATING BARREL** for years of pinpoint accuracy
- **FULLY ADJUSTABLE REAR SIGHT AND HOODED BRASS BEAD FRONT** get you on target quickly
- **BARREL-MOUNTED FRONT SLING SWIVEL** adds a classic touch
- **RECESSED TARGET CROWN** enhances accuracy and protects the rifling
- **M.O.A. TRIGGER SYSTEM** with zero take-up, zero creep and zero overtravel gives you outstanding accuracy
- **BLADE-TYPE EJECTOR** for full control of ejection force
- **PACHMAYR® DECELERATOR® RECOIL PAD** for optimal protection against "felt recoil"

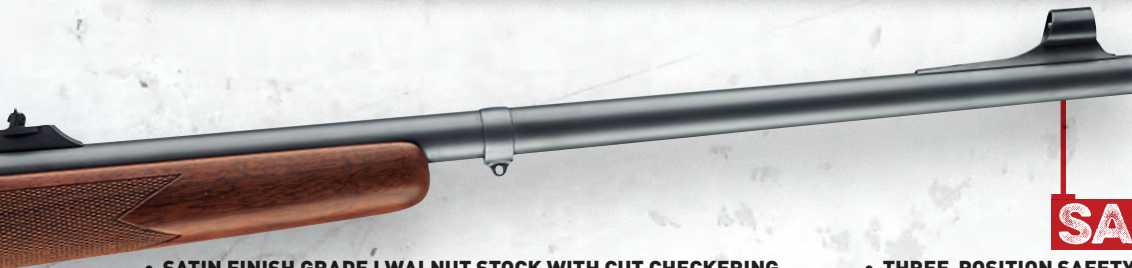

## ALASKAN

- **SATIN FINISH MONTE CARLO WALNUT STOCK WITH CUT CHECKERING** places your eye in perfect alignment with open sights or a scope
- **ALLOY ONE-PIECE BOTTOM METAL** adds rigidity for better accuracy
- **POLISHED METAL SURFACES** add style and elegance
- **FORGED STEEL RECEIVER WITH INTEGRAL RECOIL LUG** is bedded front and rear to eliminate shifts in zero for exceptional long-range accuracy
- **PRE-'64 STYLE CONTROLLED ROUND FEED WITH CLAW EXTRACTOR** fully controls the cartridge from magazine, to chamber, to ejection

- **THREE-POSITION SAFETY** allows you to unload the chamber while on safe and shows safety status at a glance
- **COLD HAMMER-FORGED FREE-FLOATING BARREL** for years of pinpoint accuracy
- **RECESSED TARGET CROWN** enhances accuracy and protects the rifling
- **FOLDING ADJUSTABLE REAR SIGHT AND HOODED BRASS BEAD FRONT** get you on target quickly
- **M.O.A. TRIGGER SYSTEM** with zero take-up, zero creep and zero overtravel gives you outstanding accuracy
- **BLADE-TYPE EJECTOR** for full control of ejection force
- **PACHMAYR® DECELERATOR® RECOIL PAD** for optimal protection against "felt recoil"



ADJUSTABLE FOLDING REAR SIGHT ON BARREL BOSS

ITEM NUMBER	CALIBER	MAGAZINE CAPACITY	BARREL LENGTH	OVERALL LENGTH	LENGTH OF PULL	DROP AT COMB	DROP AT HEEL	SIGHT RADIUS	NOMINAL WT. (LBS)	RATE OF TWIST	SUGGESTED RETAIL
<b>MODEL 70 ALASKAN</b>											
535205128	30-06 Sprg	5	25"	45 3/4"	13 3/4"	5/8"	5/8"*	18 1/2"	8 1/2	10"	\$1,399.99
535205133	300 Win Mag	3	25"	45 3/4"	13 3/4"	5/8"	5/8"*	18 1/2"	8 1/2	10"	1,399.99
535205136	338 Win Mag	3	25"	45 3/4"	13 3/4"	5/8"	5/8"*	18 1/2"	8 1/2	10"	1,399.99
535205138	375 H&H Mag	3	25"	45 3/4"	13 3/4"	5/8"	5/8"*	18 1/2"	8 1/2	12"	1,439.99

\*DROP AT MONTE CARLO IS 2"

# CARRY A FEATHER. THAT HITS LIKE A HAMMER.



**M.O.A.**  
TRIGGER SYSTEM

## FEATHERWEIGHT COMPACT

- **SATIN FINISH WALNUT STOCK WITH CLASSIC FEATHERWEIGHT CUT CHECKERING AND SCHNABEL FORE-END** create the iconic Featherweight look
- **SHORTER 13" LENGTH OF PULL** makes it perfect for younger shooters or those of smaller stature
- **POLISHED METAL SURFACES** add style and elegance
- **ALLOY ONE-PIECE BOTTOM METAL** adds rigidity for better accuracy
- **FORGED STEEL SHORT ACTION RECEIVER WITH INTEGRAL RECOIL LUG** is bedded front and rear to eliminate shifts in zero for exceptional long-range accuracy
- **PRE-'64 STYLE CONTROLLED ROUND FEED WITH CLAW EXTRACTOR** fully controls cartridge from magazine, to chamber, to ejection
- **THREE-POSITION SAFETY** allows you to unload the chamber while on safe and shows safety status at a glance
- **20" COLD HAMMER-FORGED FREE-FLOATING FEATHERWEIGHT PROFILE BARREL** for years of pinpoint accuracy
- **RECESSED TARGET CROWN** enhances accuracy and protects the rifling
- **M.O.A. TRIGGER SYSTEM** with zero take-up, zero creep and zero overtravel gives you outstanding accuracy
- **BLADE-TYPE EJECTOR** for full control of ejection force
- **PACHMAYR® DECELERATOR® RECOIL PAD** for optimal protection against "felt recoil"





**"I'M ABSOLUTELY IN LOVE WITH MY WINCHESTER MODEL 70. ITS LIGHTWEIGHT DESIGN AND INCREDIBLE ACCURACY MAKE IT THE ULTIMATE RIFLE FOR ANY SERIOUS WHITETAILER. I OWN TWO MODEL 70S CHAMBERED IN 243 WINCHESTER, AND OFTEN I CAN'T DECIDE WHICH ONE TO PICK UP WHEN I GO AFIELD. TIME AND AGAIN I FIND MYSELF GRABBING THE WALNUT STOCK VERSION, AND IT HAS NEVER LET ME DOWN!"**  
 — Terry Drury • *Drury Outdoors*



## FEATHERWEIGHT

- **SATIN FINISH WALNUT STOCK WITH CLASSIC FEATHERWEIGHT CUT CHECKERING AND SCHNABEL FORE-END** create the iconic Featherweight look
- **POLISHED METAL SURFACES** add style and elegance
- **ALLOY ONE-PIECE BOTTOM METAL** adds rigidity for better accuracy
- **FORGED STEEL RECEIVER WITH INTEGRAL RECOIL LUG** is bedded front and rear to eliminate shifts in zero for exceptional long-range accuracy
- **PRE-'64 STYLE CONTROLLED ROUND FEED WITH CLAW EXTRACTOR** fully controls cartridge from magazine, to chamber, to ejection
- **THREE-POSITION SAFETY** allows you to unload the chamber while on safe and shows safety status at a glance
- **COLD HAMMER-FORGED FREE-FLOATING FEATHERWEIGHT PROFILE BARREL** for years of pinpoint accuracy
- **RECESSED TARGET CROWN** enhances accuracy and protects the rifling
- **M.O.A. TRIGGER SYSTEM** with zero take-up, zero creep and zero overtravel gives you outstanding accuracy
- **BLADE-TYPE EJECTOR** for full control of ejection force
- **PACHMAYR® DECELERATOR® RECOIL PAD** for optimal protection against "felt recoil"



# MODEL 70



ITEM NUMBER	CALIBER	MAGAZINE CAPACITY	BARREL LENGTH	OVERALL LENGTH	LENGTH OF PULL	DROP AT COMB	DROP AT HEEL	NOMINAL WT. (LBS)	RATE OF TWIST	SUGGESTED RETAIL
<b>MODEL 70 FEATHERWEIGHT</b>										
535200210	22-250 Rem	5	22"	42 1/4"	13 3/4"	1/2"	3/4"	6 3/4	14"	\$1,009.99
535200212	243 Win	5	22"	42 1/4"	13 3/4"	1/2"	3/4"	6 3/4	10"	1,009.99
535200218	7mm-08 Rem	5	22"	42 1/4"	13 3/4"	1/2"	3/4"	6 3/4	9 1/2"	1,009.99
535200220	308 Win	5	22"	42 1/4"	13 3/4"	1/2"	3/4"	6 3/4	12"	1,009.99
535200264	270 WSM	3	24"	44 1/4"	13 3/4"	1/2"	3/4"	7	10"	1,049.99
535200255	300 WSM	3	24"	44 1/4"	13 3/4"	1/2"	3/4"	7	10"	1,049.99
535200277	325 WSM	3	24"	44 1/4"	13 3/4"	1/2"	3/4"	7	10"	1,049.99
535200225	25-06 Rem	5	22"	42 3/4"	13 3/4"	1/2"	3/4"	7	10"	1,009.99
535200226	270 Win	5	22"	42 3/4"	13 3/4"	1/2"	3/4"	7	10"	1,009.99
535200228	30-06 Sprg	5	22"	42 3/4"	13 3/4"	1/2"	3/4"	7	10"	1,009.99
535200229	264 Win Mag	3	24"	44 3/4"	13 3/4"	1/2"	3/4"	7 1/4	9"	1,049.99
535200233	300 Win Mag	3	24"	44 3/4"	13 3/4"	1/2"	3/4"	7 1/4	10"	1,049.99

<b>MODEL 70 FEATHERWEIGHT COMPACT</b>										
ITEM NUMBER	CALIBER	MAGAZINE CAPACITY	BARREL LENGTH	OVERALL LENGTH	LENGTH OF PULL	DROP AT COMB	DROP AT HEEL	NOMINAL WT. (LBS)	RATE OF TWIST	SUGGESTED RETAIL
535201210	22-250 Rem	5	20"	39 1/2"	13"	1/2"	3/4"	6 1/2	14"	\$1,009.99
535201212	243 Win	5	20"	39 1/2"	13"	1/2"	3/4"	6 1/2	10"	1,009.99
535201218	7mm-08 Rem	5	20"	39 1/2"	13"	1/2"	3/4"	6 1/2	9 1/2"	1,009.99
535201220	308 Win	5	20"	39 1/2"	13"	1/2"	3/4"	6 1/2	12"	1,009.99

[SCOPE AND MOUNTS SHOWN NOT INCLUDED.]

# GO EXTREME. THE TOUGHEST OF THE TOUGH.

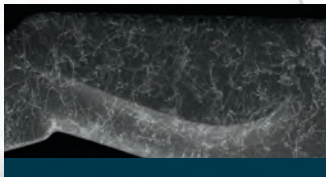

The Extreme Weather SS has a **SCULPTED CHEEKPIECE** that's beautifully functional, placing your eye in perfect alignment behind a scope.

## CROSS SECTION OF STOCK WITH ALUMINUM BEDDING BLOCK

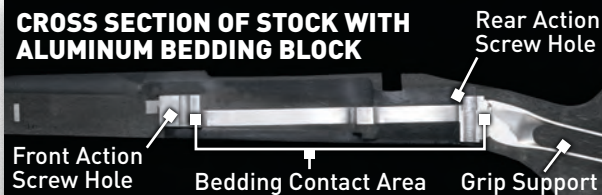

## TOP VIEW OF ALUMINUM BEDDING BLOCK



**A ONE-PIECE ALUMINUM BEDDING BLOCK** in the Extreme Weather SS and the Coyote Light is molded right into the stock during manufacturing, providing a solid, rigid base that ensures flat-out reliability. The rifle holds a tight zero, placing every shot where you aim — dead on, in any weather condition, in any season.



## TIME TO GET EXTREME ON PREDATORS

Winchester® Varmint X® ammo is designed to devastate predators. Able to deliver extreme accuracy at extended ranges, the polymer tip bullet offers instant expansion for explosive terminal performance.

# MODEL 70<sup>®</sup>

	ITEM NUMBER	CALIBER	MAGAZINE CAPACITY	BARREL LENGTH	OVERALL LENGTH	LENGTH OF PULL	DROP AT COMB	DROP AT HEEL	NOMINAL WT. (LBS)	RATE OF TWIST	SUGGESTED RETAIL
<b>MODEL 70 EXTREME WEATHER SS</b>											
	535206212	243 Win	5	22"	42 1/4"	13 3/4"	1/2"	1/2"	6 3/4	10"	\$1,339.99
	535206218	7mm-08-Rem	5	22"	42 1/4"	13 3/4"	1/2"	1/2"	6 3/4	9 1/2"	1,339.99
	535206220	308 Win	5	22"	42 1/4"	13 3/4"	1/2"	1/2"	6 3/4	12"	1,339.99
	535206264	270 WSM	3	24"	44 1/4"	13 3/4"	1/2"	1/2"	7	10"	1,379.99
	535206255	300 WSM	3	24"	44 1/4"	13 3/4"	1/2"	1/2"	7	10"	1,379.99
	535206277	325 WSM	3	24"	44 1/4"	13 3/4"	1/2"	1/2"	7	10"	1,379.99
	535206225	25-06 Rem	5	22"	42 3/4"	13 3/4"	1/2"	1/2"	7 1/8	10"	1,339.99
	535206226	270 Win	5	22"	42 3/4"	13 3/4"	1/2"	1/2"	7 1/8	10"	1,339.99
	535206228	30-06 Sprg	5	22"	42 3/4"	13 3/4"	1/2"	1/2"	7 1/8	10"	1,339.99
	535206229	264 Win Mag	3	26"	46 3/4"	13 3/4"	1/2"	1/2"	7 1/4	9"	1,379.99
	535206230	7mm Rem Mag	3	26"	46 3/4"	13 3/4"	1/2"	1/2"	7 1/4	9 1/2"	1,379.99
	535206233	300 Win Mag	3	26"	46 3/4"	13 3/4"	1/2"	1/2"	7 1/4	10"	1,379.99
	535206236	338 Win Mag	3	26"	46 3/4"	13 3/4"	1/2"	1/2"	7 1/4	10"	1,379.99

(SCOPE AND MOUNTS SHOWN NOT INCLUDED.)



## EXTREME WEATHER SS

- **BELL AND CARLSON™ SYNTHETIC STOCK WITH SCULPTED CHEEKPIECE** has a charcoal gray textured finish
- **ONE-PIECE ALUMINUM BEDDING BLOCK** adds strength and rigidity to maintain a reliable zero under adverse conditions
- **MATTE FINISHED METAL SURFACES** help reduce glare
- **ALLOY ONE-PIECE BOTTOM METAL** adds rigidity for better accuracy
- **FORGED STEEL RECEIVER WITH INTEGRAL RECOIL LUG** is bedded front and rear to eliminate shifts in zero for exceptional long-range accuracy
- **PRE-'64 STYLE CONTROLLED ROUND FEED WITH CLAW EXTRACTOR** fully controls the cartridge from magazine, to chamber, to ejection

- **THREE-POSITION SAFETY** allows you to unload the chamber while on safe and shows safety status at a glance
- **SPORTER WEIGHT STAINLESS STEEL, FREE-FLOATING FLUTED BARREL** reduces weight and improves cooling
- **RECESSED TARGET CROWN** enhances accuracy and protects the rifling
- **M.O.A. TRIGGER SYSTEM** with zero take-up, zero creep and zero overtravel gives you outstanding accuracy
- **BLADE-TYPE EJECTOR** for full control of ejection force
- **PACHMAYR® DECELERATOR® RECOIL PAD** for optimal protection against "felt recoil"



## COYOTE LIGHT

- **BELL AND CARLSON™ SYNTHETIC STOCK** has a charcoal gray textured finish and multiple fore-end vents
- **ONE-PIECE ALUMINUM BEDDING BLOCK** adds strength and rigidity to maintain a reliable zero under adverse conditions
- **MATTE FINISHED METAL SURFACES** help reduce glare
- **ALLOY ONE-PIECE BOTTOM METAL** adds rigidity for better accuracy
- **DUAL FRONT SLING SWIVEL STUDS** for sling and bipod
- **FORGED STEEL RECEIVER WITH INTEGRAL RECOIL LUG** is bedded front and rear to eliminate shifts in zero for exceptional long-range accuracy

- **PRE-'64 STYLE CONTROLLED ROUND FEED WITH CLAW EXTRACTOR** fully controls the cartridge from magazine, to chamber, to ejection
- **THREE-POSITION SAFETY** allows you to unload the chamber while on safe and shows safety status at a glance
- **MEDIUM HEAVY STAINLESS STEEL, FREE-FLOATING FLUTED BARREL** reduces weight and improves cooling
- **RECESSED TARGET CROWN** enhances accuracy and protects the rifling
- **M.O.A. TRIGGER SYSTEM** with zero take-up, zero creep and zero overtravel gives you outstanding accuracy
- **BLADE-TYPE EJECTOR** for full control of ejection force
- **PACHMAYR® DECELERATOR® RECOIL PAD** for optimal protection against "felt recoil"

[SCOPE AND MOUNTS SHOWN NOT INCLUDED.]

ITEM NUMBER	CALIBER	MAGAZINE CAPACITY	BARREL LENGTH	OVERALL LENGTH	LENGTH OF PULL	DROP AT COMB	DROP AT HEEL	NOMINAL WT. (LBS)	RATE OF TWIST	SUGGESTED RETAIL
<b>MODEL 70 COYOTE LIGHT</b>										
535207210	22-250 Rem	5	24"	44"	13 1/2"	1/2"	1/2"	7 1/2	14"	\$1,269.99
535207212	243 Win	5	24"	44"	13 1/2"	1/2"	1/2"	7 1/2	10"	1,269.99
535207220	308 Win	5	24"	44"	13 1/2"	1/2"	1/2"	7 1/2	12"	1,269.99
535207264	270 WSM	3	24"	44"	13 1/2"	1/2"	1/2"	7 1/2	10"	1,309.99
535207255	300 WSM	3	24"	44"	13 1/2"	1/2"	1/2"	7 1/2	10"	1,309.99
535207277	325 WSM	3	24"	44"	13 1/2"	1/2"	1/2"	7 1/2	10"	1,309.99

## WINCHESTER® CHOKE TUBES

Winchester® Signature choke tubes are unsurpassed in the shotgun industry. In collaboration with Briley®, one of the most renowned makers of choke tubes in the world, the Invector-Plus and Standard Invector tubes are carefully machined from the best materials and calibrated to the strictest tolerances to deliver shot patterns exceeding your highest expectations. Installing these tubes in your barrel ensures that you are getting optimum patterning for the most challenging of wild game and the most difficult presentations in clay target shooting.



### SIGNATURE INVECTOR-PLUS CHOKE TUBES

12 GAUGE FOR WINCHESTER SUPREME, SELECT, SUPER X2, SUPER X3, SUPER X4, SUPER X PUMP AND MODEL 101 SHOTGUNS

ITEM NUMBER	GA.	DESCRIPTION	DIAMETER	CONSTRIC-TION	SUGGESTED RETAIL
61307103	12	Turkey (Camo Band)	.660	.082	\$49.99
6130703	12	Extra-Full Trap	.700	.040	49.99
6130713	12	Full	.705	.035	49.99
6130723	12	Light Full	.710	.030	49.99
6130733	12	Improved Modified	.715	.025	49.99
6130743	12	Modified	.720	.020	49.99
6130753	12	Light Modified	.725	.015	49.99
6130763	12	Improved Cylinder	.730	.010	49.99
6130773	12	Skeet	.735	.005	49.99
6130783	12	Cylinder	.740	.000	49.99
6130793	12	Spreader/Diffuser	Rifled	—	74.99



### LONG BEARD® INVECTOR-PLUS CHOKE TUBE

12 GAUGE FOR WINCHESTER SUPREME, SELECT, SUPER X2, SUPER X3, SUPER X4, SUPER X PUMP AND MODEL 101 SHOTGUNS

ITEM NUMBER	GA.	DESCRIPTION	DIAMETER	CONSTRIC-TION	SUGGESTED RETAIL
61305106	12	Long Beard	.665	.077	\$69.99

### INVECTOR-PLUS CHOKE TUBES

12 GAUGE FOR WINCHESTER SUPREME, SELECT, SUPER X2, SUPER X3, SUPER X4, SUPER X PUMP AND MODEL 101 SHOTGUNS

ITEM NUMBER	GA.	DESCRIPTION	DIAMETER	CONSTRIC-TION	SUGGESTED RETAIL
613050	12	Extra-Full	.700	.040	\$34.99
613051	12	Full	.705	.035	34.99
613052	12	Improved Modified	.715	.025	34.99
613053	12	Modified	.720	.020	34.99
613054	12	Improved Cylinder	.730	.010	34.99
613055	12	Skeet	.735	.005	34.99
613056	12	Cylinder	.740	.000	34.99

### STANDARD INVECTOR CHOKE TUBES

12 GAUGE FOR WINCHESTER SUPER X2 PRACTICAL MODELS

ITEM NUMBER	GA.	DESCRIPTION	DIAMETER	CONSTRIC-TION	SUGGESTED RETAIL
6130303	12	Full	.690	.035	\$29.99
6130313	12	Improved Modified	.700	.025	29.99
6130323	12	Modified	.705	.020	29.99
6130333	12	Improved Cylinder	.715	.010	29.99
6130343	12	Skeet	.720	.005	29.99
6130353	12	Cylinder	.725	.000	29.99

### SUPER X RIFLE HINGED FLOORPLATE MAGAZINE

ITEM NUMBER	DESCRIPTION	SUGGESTED RETAIL
112029907	30-06 Sprg	\$79.99
112029906	300 Win Mag	79.99
112029904	270 WSM	79.99
112029905	300 WSM	79.99

### SUPER X RIFLE DETACHABLE FLOORPLATE MAGAZINE

ITEM NUMBER	DESCRIPTION	SUGGESTED RETAIL
112029903	30-06 Sprg	\$79.99
112029902	300 Win Mag	79.99
112029900	270 WSM	79.99
112029901	300 WSM	79.99

### XPR RIFLE DETACHABLE BOX MAGAZINE

ITEM NUMBER	DESCRIPTION	SUGGESTED RETAIL
112098800	270 Win, 30-06 Sprg	\$29.99
112098801	7mm Rem Mag, 300 Win Mag, 338 Win Mag	29.99
112098802	243 Win, 7mm-08 Rem, 308 Win	29.99
112098803	270 WSM, 300 WSM, 325 WSM	29.99

SUPER X RIFLE HINGED FLOORPLATE MAGAZINE



SUPER X RIFLE DETACHABLE FLOORPLATE MAGAZINE



XPR RIFLE DETACHABLE BOX MAGAZINE



## WINCHESTER® SCOPE BASES AND RINGS

Make sure your favorite Winchester® firearm carries its scope with Winchester bases and rings. Designed and manufactured with absolute precision from 7000-series aircraft grade aluminum alloy or solid steel (where noted) these mounts will hold today's high-magnification scopes without shifting zero.



**XPR® AND MODEL 70® RIFLE SCOPE SET WITH INTEGRATED BASES** simplify mounting and help ensure your scope will stay zeroed in adverse conditions.



**BASES AND RINGS** are available in **GLOSS FINISH** to match scope and firearm.



**WINCHESTER® BASES** for **XPR® RIFLE** and **SHOTGUNS** accept Weaver-style rings.



**SXP BASE**



**BASES for 1885 RIFLES** accept Winchester-style rings.



ITEM NUMBER	DESCRIPTION	SUGGESTED RETAIL
<b>SCOPE BASES AND RINGS</b>		
62100	Scope Set, M70, Std Height, Matte, 1"	\$69.99
62200	Scope Set, M70, Med Height, Matte, 1"	69.99
62300	Scope Set, M70, High Height, Matte, 1"	69.99
62101	Scope Set, M70, Std Height, Matte, 30mm	69.99
62201	Scope Set, M70, Med Height, Matte, 30mm	69.99
62301	Scope Set, M70, High Height, Matte, 30mm	69.99
62102	Scope Set, M70 Safari, Std Height, Matte, 1"	69.99
62202	Scope Set, M70 Safari, Med Height, Matte, 1"	69.99
62302	Scope Set, M70 Safari, High Height, Matte, 1"	69.99
62103	Scope Set, M70 Safari, Std Height, Matte, 30mm	69.99
62203	Scope Set, M70 Safari, Med Height, Matte, 30mm	69.99
62303	Scope Set, M70 Safari, High Height, Matte, 30mm	69.99
63100	Scope Set, M70, Std Height, Gloss, 1"	69.99
63200	Scope Set, M70, Med Height, Gloss, 1"	69.99
63300	Scope Set, M70, High Height, Gloss, 1"	69.99
63101	Scope Set, M70, Std Height, Gloss, 30mm	69.99
63201	Scope Set, M70, Med Height, Gloss, 30mm	69.99
63301	Scope Set, M70, High Height, Gloss, 30mm	69.99
63102	Scope Set, M70 Safari, Std Height, Gloss, 1"	69.99
63202	Scope Set, M70 Safari, Med Height, Gloss, 1"	69.99
63302	Scope Set, M70 Safari, High Height, Gloss, 1"	69.99
63103	Scope Set, M70 Safari, Std Height, Gloss, 30mm	69.99
63203	Scope Set, M70 Safari, Med Height, Gloss, 30mm	69.99
63303	Scope Set, M70 Safari, High Height, Gloss, 30mm	69.99
62620	Scope Set, XPR, Std Height, Matte, 1"	69.99
62621	Scope Set, XPR, Med Height, Matte, 1"	69.99
62622	Scope Set, XPR, High Height, Matte, 1"	69.99
64630	Scope Set, XPR, Std Height, Matte, 30mm	69.99
64631	Scope Set, XPR, Med Height, Matte, 30mm	69.99
64632	Scope Set, XPR, High Height, Matte, 30mm	69.99
63500	Steel Base, M70, Gloss	44.99
63501	Steel Base, M1885 High Wall Hunter, Gloss	104.99
63502	Steel Base, M1885 Low Wall, Gloss	104.99
63600	Steel Rings, Std Height, Gloss, 1"	99.99
63601	Steel Rings, Med Height, Gloss, 1"	99.99
63602	Steel Rings, High Height, Gloss, 1"	99.99
63603	Steel Rings, Std Height, Gloss, 30mm	99.99
63604	Steel Rings, Med Height, Gloss, 30mm	99.99
63605	Steel Rings, High Height, Gloss, 30mm	99.99
62500	Alloy Base, SXP, Matte	29.99
62501	Alloy Base, SX3/SX2, Matte	29.99
62502	Weaver-style Alloy Base, XPR, 2-Piece, Matte	24.99
62600	Weaver-style Alloy Rings, Std Height, Matte, 1"	34.99
62601	Weaver-style Alloy Rings, Med Height, Matte, 1"	34.99
62602	Weaver-style Alloy Rings, High Height, Matte, 1"	34.99
62610	Weaver-style Alloy Rings, Std Height, Matte, 30mm	34.99
62611	Weaver-style Alloy Rings, Med Height, Matte, 30mm	34.99
62612	Weaver-style Alloy Rings, High Height, Matte, 30mm	34.99

	ITEM NUMBER	GA.	CHAMBER	BARREL LENGTH	DESCRIPTION	SUGGESTED RETAIL
<b>SUPER X PUMP RIFLED BARRELS</b>						
<b>NEW</b>	611261240	12	3 1/2"	22"	Matte Blued, Rifled, TRUGLO Sights	\$179.99
	611261340	12	3"	22"	Matte Blued, Rifled, TRUGLO Sights	179.99
<b>NEW</b>	611261640	20	3"	22"	Matte Blued, Rifled, TRUGLO Sights	179.99
<b>SUPER X PUMP FIELD AND TURKEY BARRELS</b>						
<b>NEW</b>	611251290	12	3 1/2"	24"	Matte Blued, Vent Rib, with 1 Modified Invector-Plus Choke Tube	\$149.99
	611251291	12	3 1/2"	26"	Matte Blued, Vent Rib, with 1 Modified Invector-Plus Choke Tube	149.99
	611251292	12	3 1/2"	28"	Matte Blued, Vent Rib, with 1 Modified Invector-Plus Choke Tube	149.99
<b>NEW</b>	611251390	12	3"	24"	Matte Blued, Vent Rib, with 1 Modified Invector-Plus Choke Tube	149.99
	611251391	12	3"	26"	Matte Blued, Vent Rib, with 1 Modified Invector-Plus Choke Tube	149.99
	611251392	12	3"	28"	Matte Blued, Vent Rib, with 1 Modified Invector-Plus Choke Tube	149.99
<b>NEW</b>	611321291	12	3 1/2"	26"	MOBUC, Vent Rib, with 1 Modified Invector-Plus Choke Tube	189.99
<b>NEW</b>	611321292	12	3 1/2"	28"	MOBUC, Vent Rib, with 1 Modified Invector-Plus Choke Tube	189.99
	611270291	12	3 1/2"	26"	MOSGB, Vent Rib, with 1 Modified Invector-Plus Choke Tube	189.99
	611270292	12	3 1/2"	28"	MOSGB, Vent Rib, with 1 Modified Invector-Plus Choke Tube	189.99
	611254291	12	3 1/2"	26"	MODB, Vent Rib, with 1 Modified Invector-Plus Choke Tube	189.99
	611254292	12	3 1/2"	28"	MODB, Vent Rib, with 1 Modified Invector-Plus Choke Tube	189.99
	611254391	12	3"	26"	MODB, Vent Rib, with 1 Modified Invector-Plus Choke Tube	179.99
	611254392	12	3"	28"	MODB, Vent Rib, with 1 Modified Invector-Plus Choke Tube	179.99
	611251253	12	3 1/2"	24"	Matte Blued, Vent Rib, with 1 X-Full Extended Invector-Plus Choke Tube	149.99
	611251353	12	3"	24"	Matte Blued, Vent Rib, with 1 X-Full Extended Invector-Plus Choke Tube	149.99
	611257391	12	3"	26"	Matte Blued, Vent Rib 5 Shot, with 1 Modified Invector-Plus Choke Tube	139.99
	611257392	12	3"	28"	Matte Blued, Vent Rib 5 Shot, with 1 Modified Invector-Plus Choke Tube	139.99
	611293291	12	3 1/2"	26"	MOBL, Vent Rib, with 1 Modified Invector-Plus Choke Tube	189.99
	611293292	12	3 1/2"	28"	MOBL, Vent Rib, with 1 Modified Invector-Plus Choke Tube	189.99
	611260292	12	3 1/2"	28"	Max-4, Vent Rib, with 1 Modified Invector-Plus Choke Tube	189.99
	611290291	12	3 1/2"	26"	Max-5, Vent Rib, with 1 Modified Invector-Plus Choke Tube	189.99
	611290292	12	3 1/2"	28"	Max-5, Vent Rib, with 1 Modified Invector-Plus Choke Tube	189.99
	611290391	12	3"	26"	Max-5, Vent Rib, with 1 Modified Invector-Plus Choke Tube	189.99
	611290392	12	3"	28"	Max-5, Vent Rib, with 1 Modified Invector-Plus Choke Tube	189.99
<b>NEW</b>	611251690	20	3"	24"	Matte Blued, Vent Rib, with 1 Modified Invector-Plus Choke Tube	149.99
	611251691	20	3"	26"	Matte Blued, Vent Rib, with 1 Modified Invector-Plus Choke Tube	149.99
	611251692	20	3"	28"	Matte Blued, Vent Rib, with 1 Modified Invector-Plus Choke Tube	149.99
	611251653	20	3"	24"	Matte Blued, Vent Rib, with 1 X-Full Extended Invector-Plus Choke Tube	149.99
<b>SUPER X3 RIFLED BARRELS</b>						
	611108340	12	3"	22"	Matte Blued, Rifled, Cantilever Scope Mount with Synthetic Forearm*	\$579.99
	611107340	12	3"	22"	MOBU, Rifled, Cantilever Scope Mount with Synthetic Forearm*	599.99
	611121340	12	3"	22"	MOINF, Rifled, Cantilever Scope Mount with Synthetic Forearm*	599.99
<b>NEW</b>	611167340	12	3"	22"	MOBUC, Rifled, Cantilever Scope Mount with Synthetic Forearm*	599.99
	611108240	12	3 1/2"	22"	Matte Blued, Rifled, Cantilever Scope Mount with Synthetic Forearm*	579.99
	611121240	12	3 1/2"	22"	MOINF, Rifled, Cantilever Scope Mount with Synthetic Forearm*	599.99
<b>NEW</b>	611167240	12	3 1/2"	22"	MOBUC, Rifled, Cantilever Scope Mount with Synthetic Forearm*	599.99
	611062640	20	3"	22"	Matte Blued, Rifled, Cantilever Scope Mount	579.99
	611121640	20	3"	22"	MOINF, Rifled, Cantilever Scope Mount	599.99
<b>NEW</b>	611167640	20	3"	22"	MOBUC, Rifled, Cantilever Scope Mount with Synthetic Forearm*	599.99
<b>SUPER X3 FIELD AND TURKEY BARRELS</b>						
	611053261	12	3 1/2"	28"	Perma-Cote UT Gray, Vent Rib, with 1 Modified Invector-Plus Choke Tube	\$419.99
	611054371	12	3"	26"	Perma-Cote UT Gray, Vent Rib, with 1 Modified Invector-Plus Choke Tube	419.99
	611054361	12	3"	28"	Perma-Cote UT Gray, Vent Rib, with 1 Modified Invector-Plus Choke Tube	419.99
	611054691	20	3"	26"	Perma-Cote UT Gray, Vent Rib, with 1 Modified Invector-Plus Choke Tube	419.99
	611054692	20	3"	28"	Perma-Cote UT Gray, Vent Rib, with 1 Modified Invector-Plus Choke Tube	419.99
	611123291	12	3 1/2"	26"	Matte Blued, Vent Rib, with 1 Modified Invector-Plus Choke Tube	399.99
	611123292	12	3 1/2"	28"	Matte Blued, Vent Rib, with 1 Modified Invector-Plus Choke Tube	399.99
<b>NEW</b>	611123390	12	3"	24"	Matte Blued, Vent Rib, with 1 Modified Invector-Plus Choke Tube	399.99
	611123391	12	3"	26"	Matte Blued, Vent Rib, with 1 Modified Invector-Plus Choke Tube	399.99
	611123392	12	3"	28"	Matte Blued, Vent Rib, with 1 Modified Invector-Plus Choke Tube	399.99
<b>NEW</b>	611123690	20	3"	24"	Matte Blued, Vent Rib, with 1 Modified Invector-Plus Choke Tube	399.99
	611123691	20	3"	26"	Matte Blued, Vent Rib, with 1 Modified Invector-Plus Choke Tube	399.99
	611123692	20	3"	28"	Matte Blued, Vent Rib, with 1 Modified Invector-Plus Choke Tube	399.99

DO NOT ATTEMPT THE USE OF 3 1/2" CHAMBERED BARRELS WITH 3" RECEIVERS NOR 3" CHAMBERS WITH 3 1/2" RECEIVERS. \*TO PREVENT DAMAGE TO FOREARMS, THESE 12 GAUGE SUPER X3 RIFLED CANTILEVER BARRELS ARE DELIVERED WITH A NEW FOREARM SPECIFICALLY DESIGNED TO FIT OVER THE THICKER, RIFLED BARREL WALL.

ITEM NUMBER	GA.	CHAMBER	BARREL LENGTH	DESCRIPTION	SUGGESTED RETAIL
<b>SUPER X3 FIELD AND TURKEY BARRELS</b>					
611155291	12	3 1/2"	26"	MOSGB, Vent Rib, with 1 Modified Invector-Plus Choke Tube	\$499.99
611155292	12	3 1/2"	28"	MOSGB, Vent Rib, with 1 Modified Invector-Plus Choke Tube	499.99
611167291	12	3 1/2"	26"	MOBUC, Vent Rib, with 1 Modified Invector-Plus Choke Tube	499.99
611167292	12	3 1/2"	28"	MOBUC, Vent Rib, with 1 Modified Invector-Plus Choke Tube	499.99
611074271	12	3 1/2"	26"	MODB, Vent Rib, with 1 Modified Invector-Plus Choke Tube	499.99
611155691	20	3"	26"	MOSGB, Vent Rib, with 1 Modified Invector-Plus Choke Tube	499.99
611155692	20	3"	28"	MOSGB, Vent Rib, with 1 Modified Invector-Plus Choke Tube	499.99
611158291	12	3 1/2"	26"	MOBL, Vent Rib, with 1 Modified Invector-Plus Choke Tube	499.99
611158292	12	3 1/2"	28"	MOBL, Vent Rib, with 1 Modified Invector-Plus Choke Tube	499.99
611159291	12	3 1/2"	26"	Max-5, Vent Rib, with 1 Modified Invector-Plus Choke Tube	499.99
611159292	12	3 1/2"	28"	Max-5, Vent Rib, with 1 Modified Invector-Plus Choke Tube	499.99
611158391	12	3"	26"	MOBL, Vent Rib, with 1 Modified Invector-Plus Choke Tube	499.99
611158392	12	3"	28"	MOBL, Vent Rib, with 1 Modified Invector-Plus Choke Tube	499.99
611159391	12	3"	26"	Max-5, Vent Rib, with 1 Modified Invector-Plus Choke Tube	499.99
611159392	12	3"	28"	Max-5, Vent Rib, with 1 Modified Invector-Plus Choke Tube	499.99
611158691	20	3"	26"	MOBL, Vent Rib, with 1 Modified Invector-Plus Choke Tube	499.99
611158692	20	3"	28"	MOBL, Vent Rib, with 1 Modified Invector-Plus Choke Tube	499.99
611159691	20	3"	26"	Max-5, Vent Rib, with 1 Modified Invector-Plus Choke Tube	499.99
611159692	20	3"	28"	Max-5, Vent Rib, with 1 Modified Invector-Plus Choke Tube	499.99
611074692	20	3"	28"	MODB, Vent Rib, with 1 Modified Invector-Plus Choke Tube	499.99
611117291	12	3 1/2"	26"	MOINF, Vent Rib, with 1 Modified Invector-Plus Choke Tube	499.99
611117292	12	3 1/2"	28"	MOINF, Vent Rib, with 1 Modified Invector-Plus Choke Tube	499.99
611117691	20	3"	26"	MOINF, Vent Rib, with 1 Modified Invector-Plus Choke Tube	499.99
611117692	20	3"	28"	MOINF, Vent Rib, with 1 Modified Invector-Plus Choke Tube	499.99
611123253	12	3 1/2"	24"	Matte Blued, Vent Rib, TRUGLO Sights, with 1 X-Full Extended Invector-Plus Choke Tube	399.99
611123353	12	3"	24"	Matte Blued, Vent Rib, TRUGLO Sights, with 1 X-Full Extended Invector-Plus Choke Tube	399.99
611123653	20	3"	24"	Matte Blued, Vent Rib, TRUGLO Sights, with 1 X-Full Extended Invector-Plus Choke Tube	399.99

DO NOT ATTEMPT THE USE OF 3 1/2" CHAMBERED BARRELS WITH 3" RECEIVERS NOR 3" CHAMBERS WITH 3 1/2" RECEIVERS. \*TO PREVENT DAMAGE TO FOREARMS, THESE 12 GAUGE SUPER X3 RIFLED CANTILEVER BARRELS ARE DELIVERED WITH A NEW FOREARM SPECIFICALLY DESIGNED TO FIT OVER THE THICKER, RIFLED BARREL WALL.

#### CUSTOMER SERVICE FOR WINCHESTER® FIREARMS

Expect the same great customer service you've become accustomed to over the years. Expert gunsmiths can help you with the most technical problems and repairs to your firearms. There are many Authorized Repair Centers (ARC) throughout the country with gun repair professionals who know your firearm inside and out. If you need service on current models, as well as older Model 70, Model 94, Model 9422 or Model 1300 firearms, please contact one of the Authorized Repair Centers or our main Service Center in Arnold, Missouri. Please call (800) 333-3288 or visit online at <http://www.winchesterguns.com/customerservice/partsservice/index.asp> for more information.

#### WINCHESTER REPEATING ARMS®

Customer Service Department  
275 Winchester Avenue  
Morgan, UT 84050  
(800) 945-5237  
(801) 876-3440

Parts and Service  
3005 Arnold Tenbrook Road  
Arnold, MO 63010  
(800) 322-4626



ALL WINCHESTER® FIREARMS ARE SHIPPED WITH A FREE LOCKING DEVICE TO ASSIST IN THE SAFE STORAGE OF FIREARMS. (NOT SHOWN ACTUAL SIZE.)



#### FOR FIREARMS: WINCHESTERGUNS.COM

#### FOR AMMUNITION: WINCHESTER.COM

Owner's manuals for all Winchester® firearms in this or previous catalogs are available upon request at no charge. Owners of Winchester firearms without owner's manuals are encouraged to view one online or request one from our Customer Service Department. Some models and calibers are only made periodically. Winchester Repeating Arms (WRA) reserves the right to delay, postpone or discontinue production of any Winchester firearm for any reason without notice. All specifications in this catalog are subject to change without notice. Weights, stock dimensions, wood appearance, etc., may vary slightly between individual firearms. Wood is a natural product. No two pieces are alike and variation between stocks is to be expected. WRA reserves the right to modify or change specifications without notice. WRA will make every effort to make sure this catalog is accurate at the time of printing and apologizes for any errors in photographs, descriptions and specifications.

Please note that the following models are or were manufactured in Japan: Models 1866, 1873, 1885, 1886, 1892, 1894, 1895, 63 and 52B. Super X2, Super X3, Super X4 and 101 shotguns are or were manufactured in Belgium and assembled in Portugal. Model 70 rifles are manufactured in the USA or in Portugal. The following trademarks are used with permission from Olin Corporation: Winchester, the Horse and Rider design, Super X, SX2 design, Super X2, SX3 design, Super X3, SX4 design, Super X4, Model 1892, Select, Model 101, Model 1300, Model 94, Model 70, Super X Pump, Long Beard, XPR and the red W design. Other trademarks used in this catalog: Mossy Oak Shadow Grass Blades, Mossy Oak Break-Up Infinity, Mossy Oak Break-Up Country and Mossy Oak Mountain Country Range are registered trademarks of Haas Outdoors. Pachmayr and Decelerator are registered trademarks of Lyman. Invector-Plus, Dura-Touch and Perma-Cote are trademarks of Browning. TRUGLO is a trademark of TRUGLO, Inc. Marble Arms is a trademark of Marbles Arms. Weaver is a registered trademark of Vista Outdoor.

© Copyright, WRA, August 2016. No part of this catalog may be reproduced without the written permission of Winchester Repeating Arms. Suggested retail pricing is in U.S. dollars, are approximate and subject to change without notice. If you have any questions concerning Winchester brand firearms, visit your Winchester Repeating Arms dealer or write to: Winchester Repeating Arms, 275 Winchester Ave., Morgan, UT 84050-9333. Printed in USA. GAC1608125/16056 Winchester firearms are imported by BACO, Inc. Winchester is a registered trademark of Olin Corporation.

A portion of the sale of every Winchester firearm is proudly donated to the Heritage Fund, which helps to expand the legal defense against politically motivated lawsuits against the hunting and shooting industry. Working together, the rightful tradition of firearms in America will continue.





## GOULD BROTHERS® EXHIBITION SHOOTING

With little more than a vision of becoming professional exhibition shooters, the Gould Brothers searched for shotguns that would consistently perform at the highest level. They checked out all the manufacturers and both decided Winchester® was the way to go. Now, after countless rounds of practice and over six years of performing live shows on the biggest stages, the Gould Brothers are still relying on the Winchester Super X®3 and the Super X® Pump to help them amaze crowds across the country at their one-of-a-kind live exhibition shows.



## DRURY OUTDOORS

Take four members of the Drury family — Mark, Terry, Taylor and Matt — add a passion for hunting and sharing the adventure of the hunt with viewers, and you have one of the most popular and innovative family-oriented outdoor programs on TV today. If you love hunting whitetails and turkeys, you'll enjoy spending time with Winchester® and the whole DOD Team on the Outdoor Channel and the Pursuit Channel.





## WINCHESTER DEADLY PASSION

Melissa Bachman is an accomplished huntress with a unique ability to share her love for the great outdoors and all things wild with her passionate fans and viewers.

Growing up in central Minnesota, surrounded by an avid hunting family filled with love and mentors galore, Melissa pursued her academic life with the same moxie as her passion for hunting. After graduating with honors and armed with degrees in both television broadcasting and Spanish from St. Cloud State University, she trained her sights on a career in outdoor television.

Now Melissa spends nearly 200 days a year in the field, hunting, producing and editing for her television show *Winchester Deadly Passion* on the Sportsman Channel.



## GUN IT WITH BENNY SPIES

Benny Spies proudly represents the average outdoorsman, the weekend warrior, the part-time hunter, the valuable majority of which outdoor television fails to recognize.

Benny and his crew continue to entertain America on the Sportsman Channel with exciting adventures in this fresh, energized reality show that gives an authentic look at how America truly enjoys the outdoors. *Gun It with Benny Spies* presented by Leupold isn't another one of those outdoor shows where everyone is whispering in the woods while waiting for a trophy to appear. This is just a good 'ol boy out enjoying what he loves to do with his family, friends and random people throughout small town USA. Sometimes things go right and sometimes they don't! As we all know, that's just how things go.



## GUN IT WITH \*BENNY SPIES\*

PRESENTED BY



LEUPOLD





# WINCHESTER WORLD OF WHITETAIL

It's hard-core whitetail hunting at its finest. This adventure-hunting reality series is prime for whitetail fanatics across the country. Join host Ron Spomer on the Outdoor Channel as he tells all, including his strategies and tactics for taking big bucks. Viewers will also tag along and be "on-location" across the country as Ron hunts with resident experts and consults with ranch owners on how to manage for more and bigger deer, and tests the latest new products for hunting monster whitetails.



# WINCHESTER LIFE

For many people, Winchester is a lifestyle. "Winchester Life" is a new TV series that makes nature and wildlife the stars. Hosts Chris and Casey Keefer, Pete Alfano, Paul Sawyer and Nikki Boxler use epic locations and exciting hunts to bring clarity to the outdoor experience and connect at an emotional level with the viewer.

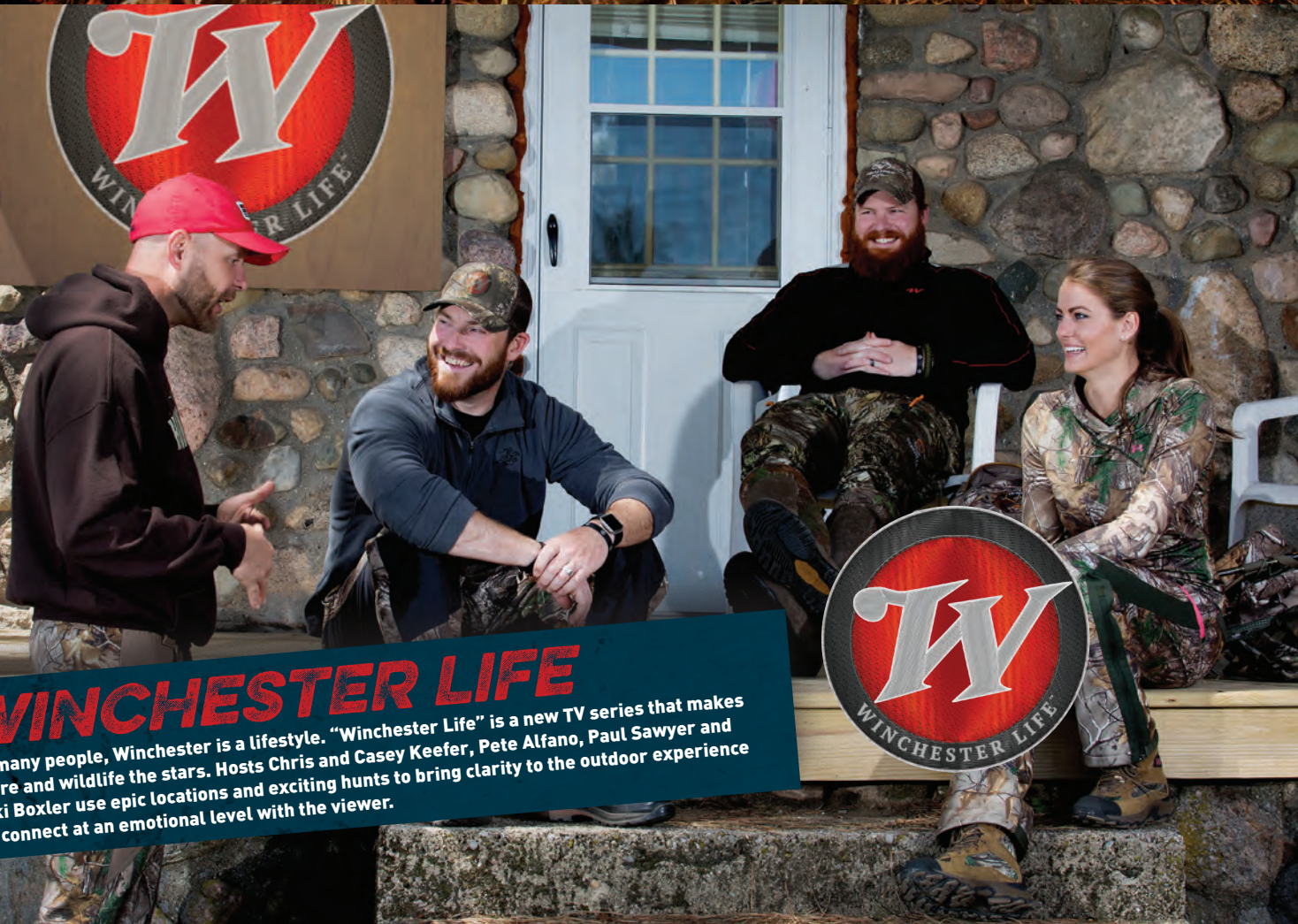



# RNT-V

## RNT-V

RNT-V is a reality based show that centers around RNT Calls, today's leading manufacturer of custom duck and goose calls. The show is unique in that it gives a behind-the-scenes look at what it is to be a hardcore waterfowler, to juggle running a waterfowl-related business, film and produce an all waterfowl television program while still finding time to spend with family and friends. It is like no other show on outdoor television. Viewers get to witness firsthand the total process of designing, developing, building, and testing new products then tagging along with the RNT crew as they scour the countryside chasing waterfowl from Canada to Arkansas.

# DROPPED



## DROPPED

Brothers Chris and Casey Keefer are well-known personalities in the outdoor and hunting world. After their boyhoods spent hunting and playing ice hockey, the pair has begun to live out their dreams and springboard their lifelong passion for the outdoors into successful careers in big-game guiding, broadcasting and as respected pro-staffers for Winchester Repeating Arms. Their current TV series *Dropped* on the Sportsman Channel literally drop the pair into some of North America's most rugged environments where they must survive by their woodcraft, wits and hunting skills, often for weeks at a time.

**WINCHESTER**<sup>®</sup>

REPEATING ARMS



WINCHESTER REPEATING ARMS  
275 WINCHESTER AVE., MORGAN, UT  
84050-9333

PRSRRT STD  
U.S. POSTAGE PAID  
PERMIT 315  
OGDEN, UT